

RELOG
All-or-nothing Relay

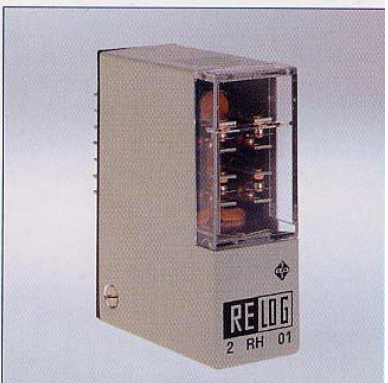
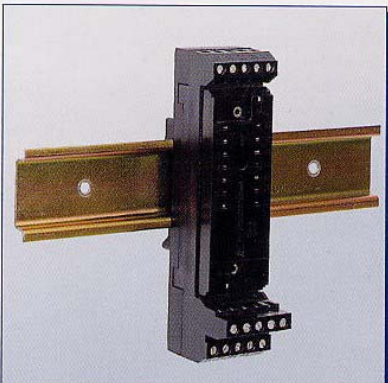
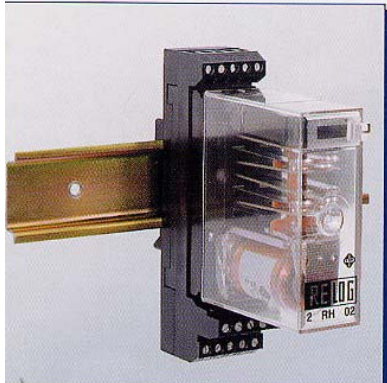

Table of Content	Page
RELOG – a system with contact components used in control engineering	3
Survey of the 'All-or-nothing relays' device program included in the RELOG system	3
Construction of all-or-nothing relays	4
Contact types	4
Contact materials	4
Suppressor circuits	5
Switching capacity	5 - 7
Range of working voltage and ambient temperature of all-or-nothing relays	8
Manufacturing quality	9
Useful life	9
Conformity with standards	9
CE conformity	9
Technical parameters	10 - 16
Accessories	17 - 18
Circuit diagrams	18 - 22
Dimensioned drawings	22 - 24
List of order numbers (PI nos.)	25 - 32
List of extended order numbers	33
Accessories	33

RELOG – a Contact Component System for Control Engineering

Classical all-or-nothing relays have not lost their importance in electrical engineering. In future, they will continue to be a significant, universally applicable component. Type and arrangements fully meeting the requirements with high reliability can be chosen from a wide range of varieties.

RELOG is the name of a system of modernly designed electromechanical relays. They are fulfilling the high requirements to contemporary industrial controls.

The RELOG contact component system comprises different relays in the control engineering field, often offered as single function in different dimensions, to constitute a useful coordinated system being in line with uniform electrical and constructive aspects.

The all-or-nothing relays pertaining to the RELOG system are particularly suitable to be applied in small automation systems and to realize different control tasks, i.e., machine controls of any kind, elevator controls, control in energy-generating and distributing plants and in many other fields of control and plant construction.

Here, these relays can be used in many fields of control in the fields of input, connection, signal or output circuits covering small and medium switching capacities, where matter are focusing on a high contact reliability and a long-term stability under unfavorable ambient conditions.

RELOG all-or-nothing relays have been developed for different specific applications. They meet the required operating conditions with high a reliability. These are, for example:

- DC all-or-nothing relays with an extended voltage range acc. to UIC and a high working temperature range allow the use in plants subject to high voltage and temperature variations, as for instance, in electrical devices on railway vehicles.
- all-or-nothing relay arrangement for DC (remanence relay) with two stable switching states independent on the operating voltage is suitable for either pulse operation as well as for continuous operation. Memory functions can be fulfilled due to the magnetic latching. The advantageous application of the all-or-nothing relay is its use in any units where the switching state must be maintained despite voltage failures. The control by pulses allows an essential power reduction, so that it is advantageous for battery-operated units.
- An all-or-nothing relay arrangement for AC or DC current control allows the application in units, where the current is monitored, or where processes should be controlled by current. They are particularly suitable as monitoring relay for lamps / position lights. In this case, their winding is in series with the lamps.
- All-or-nothing relay arrangements for AC or DC with visual indication function to indicate the switching state can be equipped with a target in working current arrangement (signals relay in operated condition) and/or closed-circuit arrangement (signals relay in initial state) or they can be equipped with a resettable drop indicator.

The all-or-nothing relays of the RELOG system are supplied in enclosures with clamp-type terminals. By using plug-in connection for quick fastening of bars and/or screw fixing over the fastening sheet, screw-type terminals are possible while maintaining the intermateability. However, it is also possible to accomplish the connection through plug-in connections for solder or wrap terminations and/or adapters with a screw-type terminal for screw fixings used for massive walls or switchboards.

Survey of the Device Program for All-or-Nothing Relays of the RELOG - System

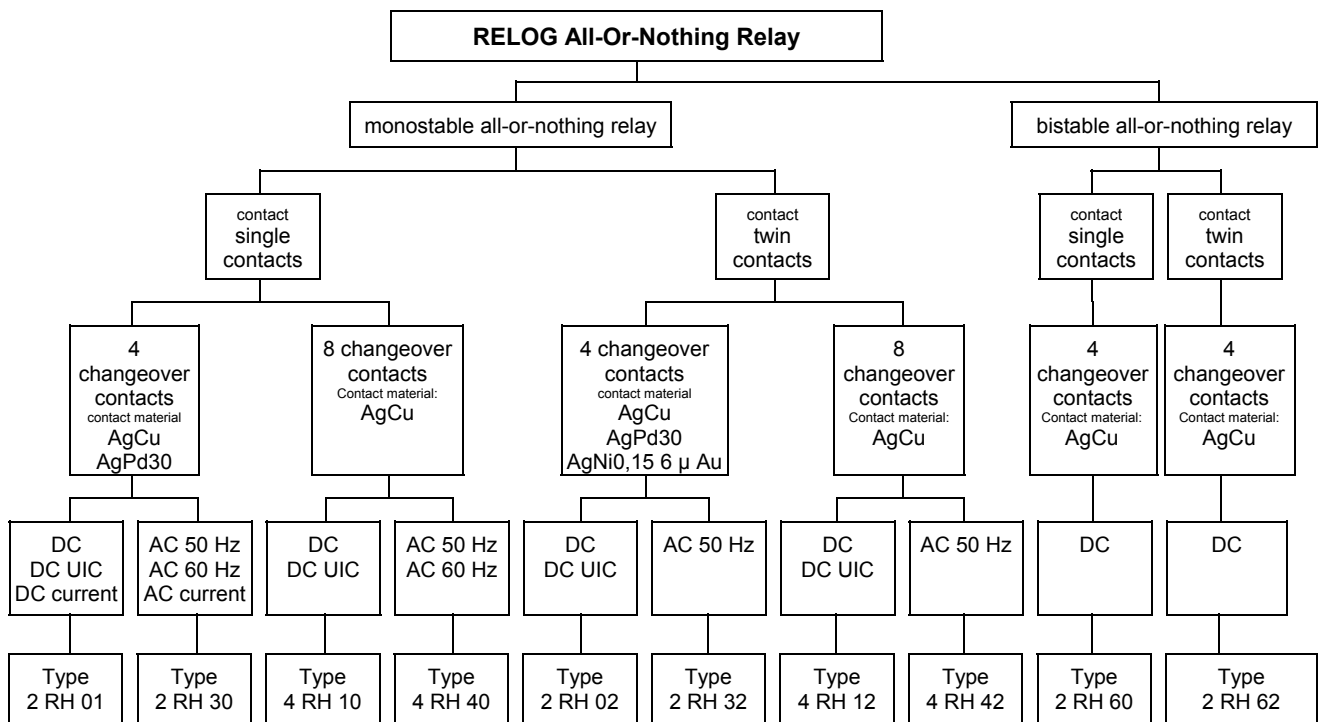

Construction of the All-or-Nothing Relay

The driving and the switching element of the relay are arranged on a lead frame made of molding material.

The driving element is designed as clapper-type armature, for DC made of electrical relay iron, for AC made of a special alloy, in a massive form and with high surface protective coating.

The relay contacts and coil terminals are designed as plug-in blades.

Driving and switching system are provided with a transparent PC cover that allows to monitor the contact elements.

The all-or-nothing relays may also be equipped with a free-wheeling diode type GP02 40 (4 kV reverse voltage) arranged between the terminal connections 1.7 (cathode) and 3.7 (anode).

Driving and switching systems in all-or nothing relays with extended voltage range acc. to UIC and relays to monitor current or position lamps are covered by a metal cover conductively connected with two leading earthing plug-in blades. A transparent insert in the cover allows to monitor the contact elements.

All-or-nothing relays can be equipped with a target in working current arrangement (signals that the relay is in the operated condition) and/or closed-circuit arrangement (signals that the relay is in the initial state) or they can be equipped with a resettable drop indicator (except degree of protection IP 50).

For the double components 4 RH all-or-nothing relays, two relay systems are combined, electrically and mechanically, in such a way to jointly switch all in all 8 changeover contacts. These relays are covered by a metal cover conductively connected with two leading earthing plug-in blades. A transparent insert in the cover allows to monitor the contact elements.

Contact Types

A variety of different factors influence the reliability of the contact making process of all-or-nothing relays. Due to the correct choice of the contact material, the relay enclosure, and the contact design any switching problem can be solved in the field of relay engineering.

For RELOG all-or-nothing relays we differentiate between single or twin contacts. In twin contacts, each contact spring is equipped with two smaller contacts, where the changeover spring is bifurcated for purposes of a uniform power distribution. Due to their higher contact material quantity single contacts have a higher switching capacity compared to twin contacts. However, in case of dusty atmospheres, twin contacts have a 20- to 100-fold higher contact making reliability.

Contact Materials

The following contact materials are used in RELOG all-or-nothing relays:

• Hard silver AgCu

Features:	high hardness in contrast to fine silver high electrical and thermal conductivity tends to form oxide and sulfide layers at sulphurous atmospheres contact resistances $\approx 30 \text{ m}\Omega$
Application:	General application at medium AC and DC loads in power and light-current engineering
Scope of application:	single contacts 24 V ... 250 V / 10 mA ... 10 A, twin contacts 12 V ... 250 V / 5 mA ... 5 A

• Silver palladium AgPd30

Features:	high arc-resistance high corrosion resistance highly resistant against (hydrogen sulphide) relatively constant contact resistances $\approx 40 \text{ m}\Omega$
Application:	use in unfavorable ambient conditions (sulphurous atmosphere) for a required high endurance at medium loads application at medium AC and DC load in power and light-current engineering
Scope of application:	single contacts: 24 V 250 V / 50 mA ... 10 A, twin contacts: 12 V 250 V / 25 mA ... 5 A

• Fine grain silver, gilded - AgNi0,15Au6 "soft"

Features:	high corrosion resistance high electrical and thermal conductivity high contact reliability due to gold plating relatively constant contact resistances over a long time contact resistances $\approx 20 \text{ m}\Omega$ at higher loads after erosion of the golden layer – features as for silver-nickel contacts
Application:	switching of low loads with high contact reliability
Scope of application:	twin contacts 1 mV ... 250 V / 1 mA ... 100 mA, max. up to 5 A with property of silver-nickel after erosion of golden layer

Other contact materials such as AgNi0,15, AgNi10, AgSnO₂ can also be supplied upon request and in an appropriate number.

Suppressor Circuits

Suppressor circuits are used to protect from cut-off voltage peaks caused by switching of inductivities and the reduction of contact load.

It prevents, among other things, the malfunction and/or destruction of electrical and insulation parts caused by overvoltage, radio disturbance as well as it reduces material migration and contact erosion.

The suppressor circuit should be placed directly at the trouble spot.

Normal suppressor circuits are:

• Diode suppressor circuits

- Advantages:
- no overvoltage (only approx. 0.7 V)
 - low costs
- Disadvantages:
- only for DC
 - causes a dropout delay at the relay
 - not protected against polarity reversal

• Varistor suppressor circuits

- Advantages:
- for DC and AC
 - only low dropout times at the relay
 - low costs
 - protected against polarity reversal
- Disadvantages:
- relatively high remaining overvoltage

• RC suppressor circuits

- Advantages:
- for DC and AC
 - low overvoltage
 - only low dropout times at the relay
 - protected against polarity reversal
- Disadvantages:
- relatively high switch-on peaks
 - not for small voltages
 - increased dropout times at the relay
 - R and C must be optimized for L_{coil}

Switching Capacity

Alternating Current - Switching Capacity, Electrical Endurance

The electrical endurance is mainly determined by contact erosion caused by the arc during the make and break of contacts when switching the load. Bouncing of contacts increases the erosion.

Since - due to the high generation of heat at the contacts when switching the load, the contact material vaporizes and/or splashes away, the erosion resistance of the contact material has a great influence on the electrical endurance.

Contact endurance – depending on the switching capacity for different contact materials and relay types - may be taken from the following diagrams, switching rate $\leq 3,600$ cycles/h

at a resistive load of ($\cos \varphi = 1$) —————

at a reactive load of ($\cos \varphi = 0.4$) - - - - -

The contact endurance given in the diagrams refers to a completely asynchronous switching of the all-or-nothing relays.

For switching currents between 4 A and 10 A, the type-dependent parameter to the maximum permissible continuous current and/or limiting continuous current have to be observed.

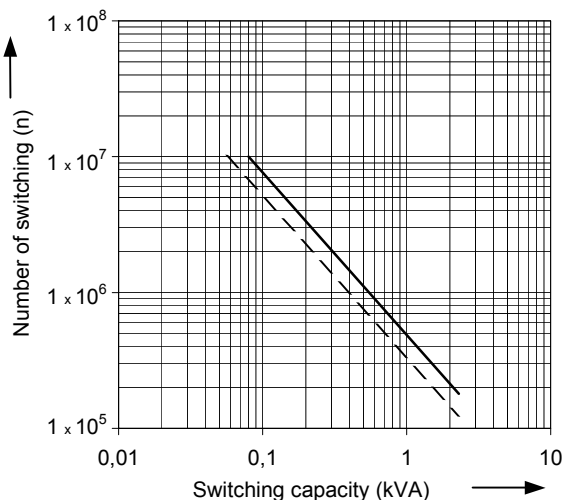

2 RH 01, 2 RH 30, 2 RH 60, 4 RH10, 4 RH 40
contact material: AgCu

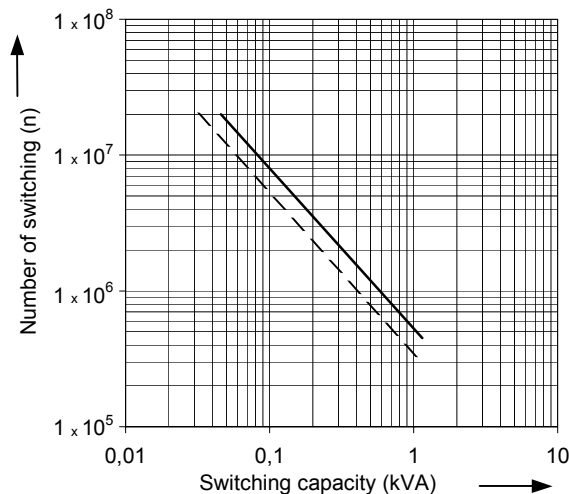

2 RH 02, 2 RH 62, 4 RH12
contact material: AgCu

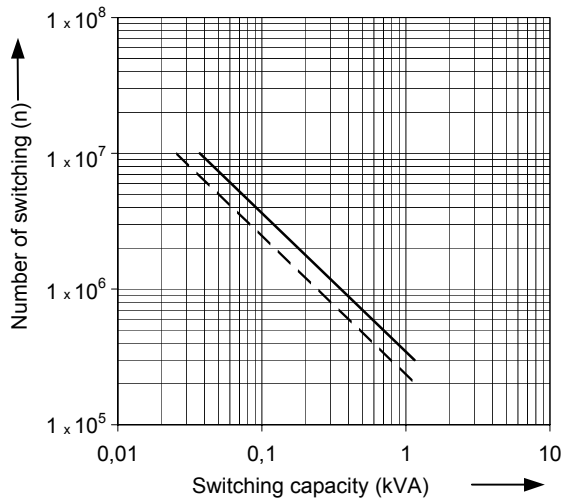

2 RH 32, 4 RH 42
contact material: AgCu

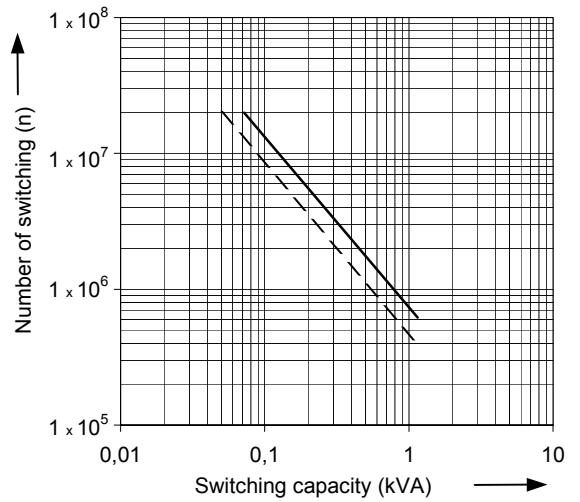

2 RH 02
contact material: AgNi0,15Au6

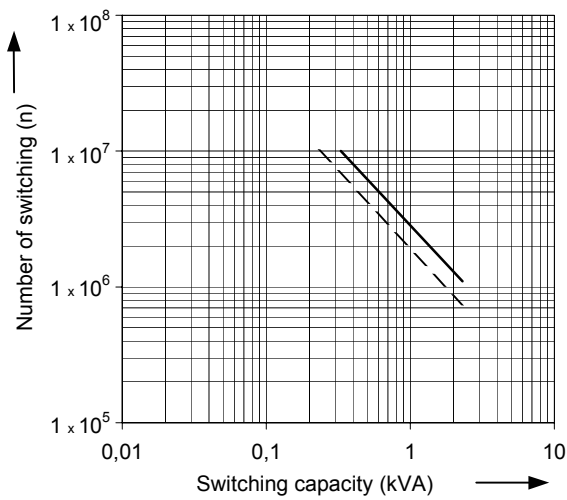

2 RH 01
contact material: AgPd30

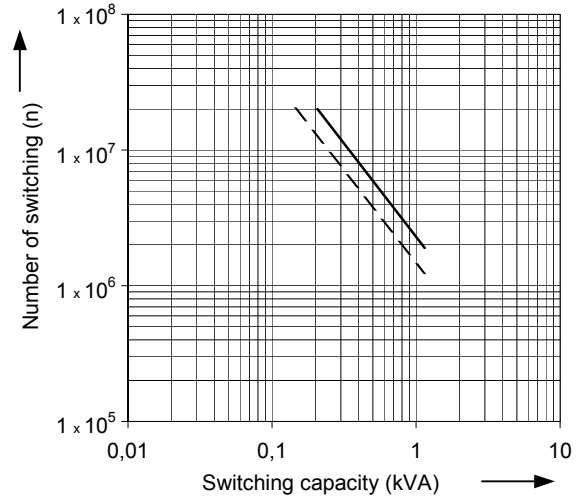

2 RH 02
contact material: AgPd30

The increased contact erosion when reactive load is applied where the stored energy in the reactive load cycle causes a longer burning of the arcs when opening the contacts results into a reduced contact endurance compared to resistive load.

The correction factor of the electrical endurance C depending on the power factor $\cos \varphi = 0,3 \dots 1$ can be seen in the following diagram.

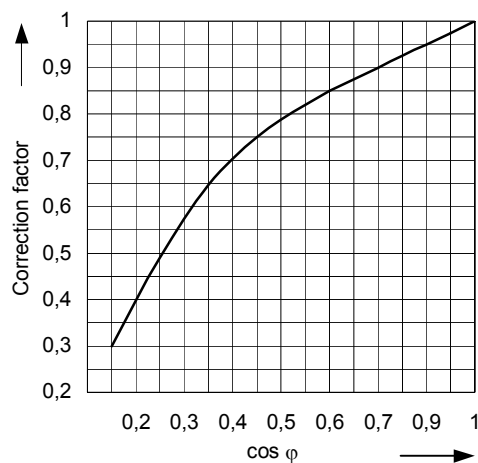

Direct Current – Switching Capacity, Electrical Endurance

When direct current is applied – in contrast to alternating current, where the arc goes out in current zero, there might be the problem of formation of a standing arc at resistive and reactive load in combination with high voltage. The arc is mainly influenced by contact load, contact distance, contact speed and contact material.

The maximum breaking current dependent on the switching voltage and on the number of series-connected contact elements is shown in the following diagram.

The given values refer to a contact endurance of $\geq 1 \times 10^4$ operating cycles at an operating frequency of $\leq 3,600$ cycles per hour and shall be regarded as limits of load capability.

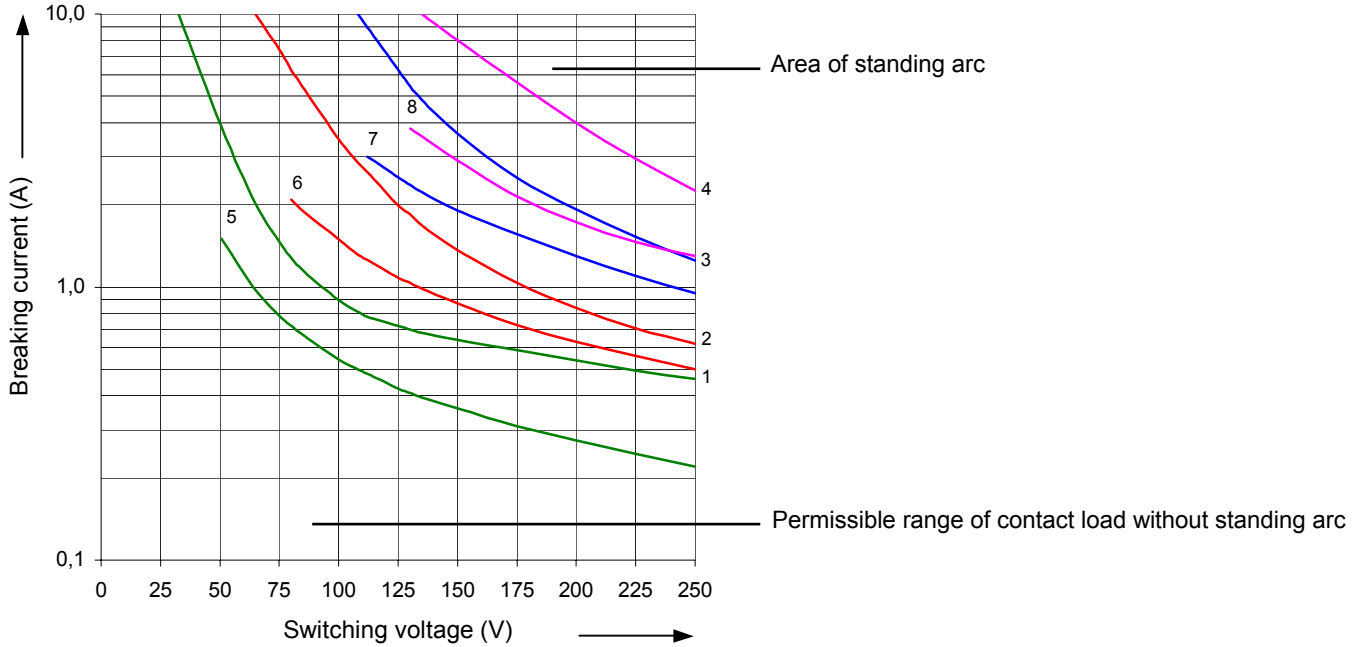

Direct current – limiting breaking capacity:

Characteristic from 1 to 4: reactive load $\tau = 0$ ms
 1 \Rightarrow 1 contact
 2 \Rightarrow 2 contacts in series
 3 \Rightarrow 3 contacts in series
 4 \Rightarrow 4 contacts in series

Characteristic from 5 to 8: resistive load $\tau = 40$ ms
 5 \Rightarrow 1 contact
 6 \Rightarrow 2 contacts in series
 7 \Rightarrow 3 contacts in series
 8 \Rightarrow c Contacts in series

Data on the electrical endurance at resistive or reactive DC load can only be obtained from switching tests with original load. Switching of DC loads results into material transfer at the contacts, from the anode to the cathode, depending on the load. To reduce this material transfer from contact to contact and to extinguish the arc in a better way, measures extinguishing the arc should be taken (see also paragraph "Suppressor Circuits").

The electrical endurance for some values depending on the series-connected contacts, operating frequency $\leq 3,600$ cycles per hour, without arc-extinguishing measures, can be taken from the following table.

Contact load	Contact material	Contact start	1 contact	2 contacts in series	3 contacts in series	4 contacts in series
220 V – 0.40 A $\tau = 0$ ms	AgCu	single contacts	$8,0 \times 10^6$			
220 V -0.50 A $\tau = 0$ ms	AgCu	single contacts	$3,0 \times 10^6$			
220 V -0.60 A $\tau = 0$ ms	AgCu	single contacts		$1,5 \times 10^6$		
220 V -0.75 A $\tau = 0$ ms	AgCu	single contacts		$0,5 \times 10^6$		
220 V -1.00 A $\tau = 0$ ms	AgCu	single contacts			$0,7 \times 10^6$	
220 V -1.50 A $\tau = 0$ ms	AgCu	single contacts			$0,2 \times 10^6$	
220 V -2.00 A $\tau = 0$ ms	AgCu	single contacts				$1,0 \times 10^6$
220 V -3.00 A $\tau = 0$ ms	AgCu	single contacts				$0,5 \times 10^6$
220 V -0.15 A $\tau = 40$ ms	AgCu	single contacts	$1,0 \times 10^6$			
220 V -0.25 A $\tau = 40$ ms	AgCu	single contacts	$0,5 \times 10^6$			
220 V -0.45 A $\tau = 40$ ms	AgCu	single contacts		$0,5 \times 10^6$		
220 V -0.50 A $\tau = 40$ ms	AgCu	single contacts			$0,3 \times 10^6$	
220 V -0.40 A $\tau = 0$ ms	AgNi0,15Au6	twin contacts	$8,0 \times 10^6$			
220 V -0.10 A $\tau = 40$ ms	AgNi0,15Au6	twin contacts	$1,0 \times 10^6$			
220 V -0.40 A $\tau = 0$ ms	AgPd30	twin contacts	$8,0 \times 10^6$			
220 V -0.05 A $\tau = 40$ ms	AgPd30	twin contacts	$2,0 \times 10^6$			

Working Voltage Range and Ambient Temperature Range of All-or-Nothing Relays

All-or-nothing relays with an extended voltage range acc. to UIC and such relays with a metal cover can be applied principally outside the nominal range of use.

In the following operating voltage diagrams, the permissible ratio of the working voltage to the rated voltage dependent on the ambient temperature is shown under different operating conditions.

The maximum permissible working voltage for the all-or-nothing relays reduces with an increasing temperature.

Working voltage range for the following all-or-nothing relays:
2 RH 01, 2 RH 02 voltage range acc. to UIC

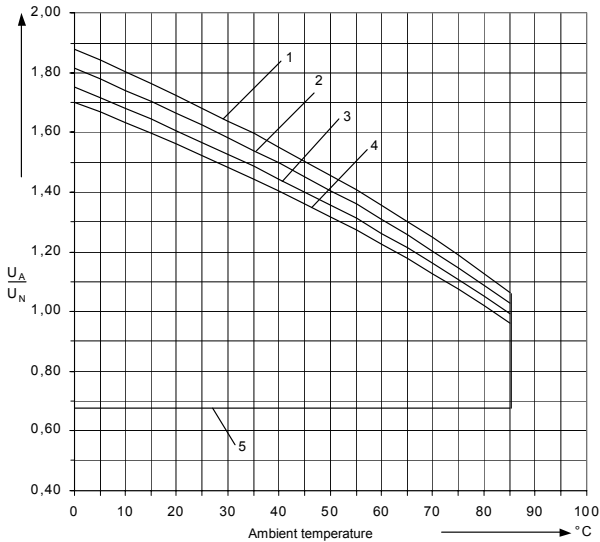

Working voltage range for the following all-or-nothing relays:
2 RH 01 normal voltage range (metal cover)

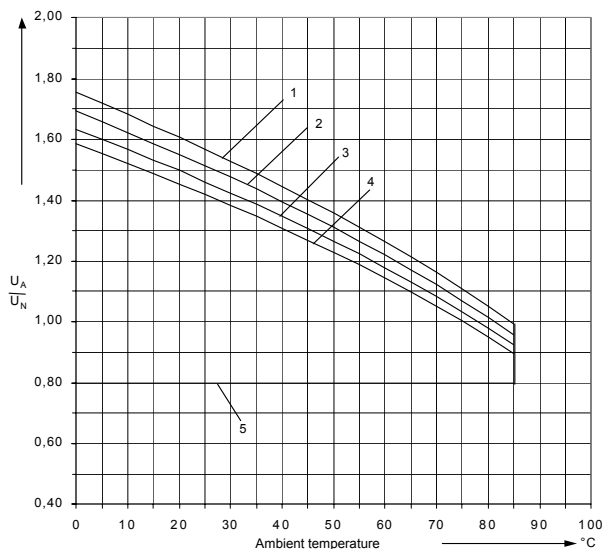

- 1 ⇒ Max. permissible operating voltage at single installation without contact load
- 2 ⇒ Max. permissible operating voltage at single installation, contact limiting current 4 A over 4 make contacts
- 3 ⇒ Max. permissible operating voltage at block installation and without contact load
- 4 ⇒ Max. permissible operating voltage at block installation, continuous contact limiting current 4 A over 4 make contacts
- 5 ⇒ Min. Response voltage at leading operation with maximum permissible operating voltage, single installation and/or block installation
Continuous contact limiting current 4 A over 4 make contacts and thermal balance state of the end temperature of coil

Working voltage range for the following all-or-nothing relays:
4 RH 10, 4 RH 12 voltage range acc. to UIC

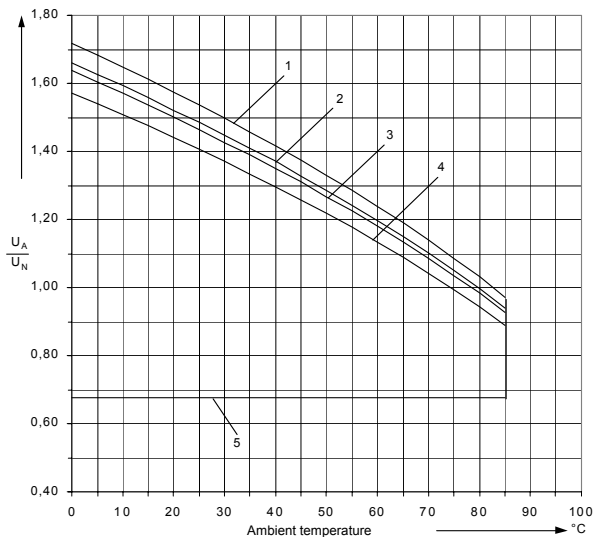

Working voltage range for the following all-or-nothing relays:
4 RH 10, 4 RH 12 normal voltage range

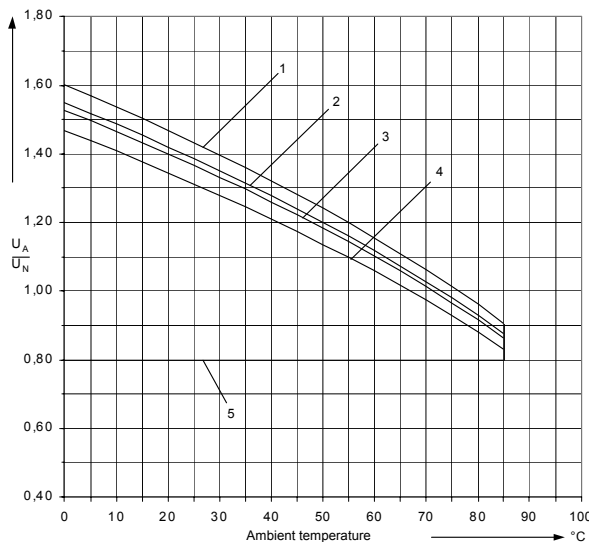

- 1 ⇒ Max. permissible operating voltage at single installation without contact load
- 2 ⇒ Max. permissible operating voltage at single installation, contact limiting current 3.6 A over 8 make contacts
- 3 ⇒ Max. permissible operating voltage at block installation and without contact load
- 4 ⇒ Max. permissible operating voltage at block installation, continuous contact limiting current 3.6 A over 8 make contacts
- 5 ⇒ Min. response voltage at leading operation with maximum permissible operating voltage, single installation and/or block installation
Continuous contact limiting current 3.6 A over 8 make contacts and thermal balance state of the end temperature of coil

Manufacturing Quality

The products of the RELOG system are manufactured in line with a quality management system according to the requirements of the DIN EN ISO 9004 standard as well as they are documented in line with DIN EN ISO 9001.

Useful Life

Expectance value ≥ 20 years, provided the electrical and/or mechanical endurance are not exceeded before.

Conformity with Standards

The data given for the RELOG all-or-nothing relays, including accessories, refer to the following national and international standards:

DIN VDE 0435-110 / VDE Part 110: 1989-04

Electrical relays; terms

DIN EN 60810-1 / VDE 0435 Part 201: 1999-04

Electromechanical non-specified-time relays,
Part 1: General Requirements

DIN EN 60810-5 / VDE 0435 Part 140: 1999-04

Electromechanical non-specified-time relays,
Part 5: Insulation coordination

DIN EN 60255-23 / VDE 0435 Part 120: 1997-03

Part 23: Electrical relays; contact behavior

DIN EN 60529 / VDE 0470 Part 1: 2000-12

Degrees of protection provided by enclosure (IP code)

DIN EN 60999-1 / VDE 0609 Part 1: 2000-12

Connecting devices – electrical copper conductors – safety requirements for screw-type terminals and screwless terminals

DIN EN 60068-2-1:1995-03

Environment tests – Part 2: Tests, test A: cold

DIN EN 60068-2-2:1994-08

Environment tests- part 2 tests, test B: dry heat

IEC 60068-2-3: 1969-01

Environment tests – Part 2: tests, test Ca: Continuous damp heat

DIN EN 60068-2-30:2000-02

Environment tests- part 2 tests, test Db40: Cyclical damp heat

DIN EN 60068-2-11:2000-02; environment tests – Part 2 Tests; test Ka: Salt fog.

IEC 60068-2-42: 1982-01 / IEC 60068-2-43: 1976-01

Environment tests – part 2 tests; (corrosive atmosphere) test Ki (Kc + Kd): sulphur dioxide + hydrogen sulphide

DIN EN 60068-2-29:1995-03

Environment tests- part 2 tests, test Eb: shock test

DIN EN 60068-2-6:1996-05

Environment tests- part 2 tests, test Fc: vibrations, sinusoidal

CE Conformity

Presently, no CE labeling for "Electromechanical non-specified-time relays" is required in the guidelines.

However, the all-or-nothing relays of the RELOG system mounted on plug-in connections for quick-rail fastenings and/or screw-type fastenings with a screw terminal are in line with the regulations of the European guidelines

73/23/EEC "Low-voltage guideline" as of 19.02.1973

89/392/EEC of 03.05.89

including their modifications.

The CE marking will be attached to the package or on the side print of the relay.

Technical Parameters

Monostable 2 RH 01, 4 RH 10 all-or-nothing relays for direct voltage

Parameters	Relay type		2 RH 01	2 RH 01	2 RH 01	4 RH 10
rated voltages U_N	6 V to 220 V DC					12 V to 220 V DC
Response voltage	$\leq 0.8 \times U_N$					
max. working voltage	$1.1 \times U_N$					
operating mode	continuous operation					
Dropout voltage	$\geq 5\%$ of U_N					
Ambient temperature	- 40°C up to + 55°C at individual installation - 40°C up to +50°C at block installation					
Rated consumption:	≤ 2.5 W				≤ 5.0 W	
Function indicator	without function indicator or with target / drop indicator				without	
GP02-40 free-wheeling diode	with or without				without	
max. switching voltage	≤ 250 V AC/DC					
Number of contacts	4 changeover contacts				8 changeover contacts	
Contact arrangement	single contacts					
Material of contact-tip	AgCu	AgPd30	AgCu			
Contact circuit resistance (24 V-, 100 mA, new condition)	approx. 30 m Ω	approx. 40 m Ω	approx. 30 m Ω			
Maximum making capacity	10 A DC/AC		3 A DC/AC	10 A DC/AC		
Maximum permitted continuous current	5 A the sum of the square of the single currents must not exceed 64 A ²		3 A the sum of the square of the single currents must not exceed 9 A ²	5 A the sum of the square of the single currents must not exceed 104 A ²		
Limiting continuous current	4 A over four making contact circuits		1.5 A over four making contact circuits	3.6 A over eight making contact circuits		
Operating frequency	$\leq 3,600$ switching cycles per hour					
Mechanical endurance without function indication with target, drop indicator	$\geq 10 \times 10^6$ switching cycles $\geq 0,1 \times 10^6$ switching cycles				$\geq 10 \times 10^6$ switching cycles -	
Rated breaking capacity • $\cos \varphi = 1.0$ 230 V AC • $\cos \varphi = 0.4$ 230 V AC • $\tau = 0$ ms 220 V DC • $\tau = 40$ ms 220 V DC	1.5 A 1.0 A 0.4 A 0.15 A	1.5 A 1.0 A 0.4 A 0.05 A	1.5 A 1.0 A 0.4 A 0.15 A			
Minimum switching capacity	24 V-, 10 mA, $\tau = 0$ ms	24 V-, 50 mA, $\tau = 0$ ms	24 V-, 10 mA, $\tau = 0$ ms			
Voltage endurance • at rated breaking capacity • at inherent load • at minimum switching capacity	$\geq 2,0 \times 10^6$ $\geq 5,0 \times 10^6$ $\geq 10 \times 10^6$	$\geq 10 \times 10^6$ $\geq 10 \times 10^6$ $\geq 10 \times 10^6$	$\geq 2,0 \times 10^6$ $\geq 2,5 \times 10^6$ $\geq 10 \times 10^6$			
response time of make contacts • without function indication • with target, drop indicator	≤ 25 ms ≤ 35 ms				≤ 25 ms -	
closing time of a break contact • with free-wheeling diode	≤ 15 ms ≤ 80 ms				≤ 20 ms ≤ 80 ms	
rated alternating insulation voltage	2 kV					
degree of pollution	3 acc. to DIN VDE 0110-1					
Impulse voltage withstand level	4.0 kV, voltage form 1.2/50 μ s					
Clearances in air	≥ 3 mm					
Creep age distances	≥ 4 mm					
Site altitude	$\leq 2,000$ m above sea level					
Relay enclosure	bifurcated plastic cover (PC), transparent		closed plastic cover (PC), transparent	Closed metal cover (Al) transparent display window		
Insulation resistance	$\geq 1 \times 10^8 \Omega$ in new condition, $U_P = 500$ V					
Degree of protection	IP40 enclosure IP00 connecting plug-in blades IP20 connecting terminals with plug-in connection for quick-rail fixings					
Climatic type of construction	normal or climatic type of construction for ships					
Environment tests	values on request					
Weight	about 0.22 kg				about 0.44 kg	

Monostable 2 RH 02, 4 RH 12 all-or-nothing relays for direct voltage

Relay type					4 RH 12
Parameters	2 RH 02	2 RH 02	2 RH 02	2 RH 02	4 RH 12
rated voltages U_N	6 V to 220 V DC				12 V to 220 V DC
Response voltage	$\leq 0,8 \times U_N$				
max. working voltage	$1,1 \times U_N$				
operating mode	continuous operation				
Dropout voltage	$\geq 5\%$ of U_N				
Ambient temperature • at single installation • at block installation	-40°C up to +50°C -40°C up to +45°C			-40°C up to +55°C -40°C up to +50°C	
Rated consumption:	≤ 2.5 W				≤ 5.0 W
Function indicator	with or without target and/or drop indicator	with or without target	with or without target and/or drop indicator		without
GP02-40 free-wheeling diode	with or without				Without
max. switching voltage	≤ 250 V AC/DC				
Number of contacts	4 changeover contacts				8 changeover contacts
Contact arrangement	single contacts				
Material of contact-tip	AgCu		AgNi0,15Au6	AgPd30	AgCu
Contact circuit resistance 24 V-, 100 mA, new condition	30 m Ω		20 m Ω	40 m Ω	30 m Ω
Maximum making capacity	10 A DC/AC				
Maximum permitted continuous current	3 A the sum of the squares of the single currents must not exceed 64 A ² in single installation, and 23 A ² in block installation				5 A the sum of the square of the single currents must not exceed 104 A ²
Limiting continuous current	4 A at single installation 2.4 A at block installation (over four making contact circuits)				3.6A (over eight making contact circuits)
Switching frequency	$\leq 3,600$ cycles / hour	≤ 1200 cycles / hour	$\leq 3,600$ switching cycles per hour		
Mechanical endurance • without function indication • with sign, drop indicator	$\geq 20 \times 10^5$ switching cycles $\geq 0,1 \times 10^6$ switching cycles				$\geq 10 \times 10^6$ cycles -
Rated breaking capacity • $\cos \varphi = 1.0$ 230 V AC • $\cos \varphi = 0.4$ 230 V AC • $\tau = 0$ ms 220 V DC • $\tau = 40$ ms 220 V DC	1.5 A 1.0 A 0.4 A 0.1 A		1.5 A 1.0 A 0.4 A 0.05 A	1.5 A 1.0 A 0.4 A 0.1 A	
Minimum switching capacity	24 V-, 5 mA, $\tau = 0$ ms		24 V-, 1 mA, $\tau = 0$ ms	24 V-, 25 mA, $\tau = 0$ ms	24 V-, 5 mA, $\tau = 0$ ms
Voltage endurance • at rated breaking capacity • at inherent load • at minimum switching capacity	$\geq 2,0 \times 10^6$ (AC) $\geq 1,0 \times 10^6$ (DC) $\geq 2,5 \times 10^6$ $\geq 10 \times 10^5$		$\geq 3,0 \times 10^6$ (AC) $\geq 1,0 \times 10^6$ (DC) $\geq 5,0 \times 10^6$ $\geq 10 \times 10^6$	$\geq 5,0 \times 10^6$ (AC) $\geq 2,0 \times 10^6$ (DC) $\geq 10 \times 10^6$ $\geq 10 \times 10^6$	$\geq 2,0 \times 10^6$ (AC) $\geq 1,0 \times 10^6$ (DC) $\geq 2,5 \times 10^6$ $\geq 10 \times 10^6$
response time of make contacts • without function indication • with sign, drop indicator	≤ 25 ms ≤ 35 ms				≤ 25 ms -
closing time of a break contact • without free-wheeling diode • with freewheeling diode	≤ 25 ms ≤ 80 ms				
Rated alternating insulation voltage	2 kV				
degree of pollution	3 acc. to DIN VDE 0110-1				
Impulse voltage withstand level	4.0 kV, voltage form 1.2/50 μ s				
Clearances in air	≥ 3 mm				
Creep age distances	≥ 4 mm				
Site altitude	$\leq 2,000$ m above sea level				
Relay enclosure	closed plastic covers (PC), transparent				Closed metal cover (Al) display window transparent
Insulation resistance	$\geq 1 \times 10^8 \Omega$ in new condition, $U_P = 500$ V				
Degree of protection • enclosure • Connecting plug-in blades • terminal with plug-in connection for quick-rail fixing	IP 40 IP 00 IP 20	IP 50 IP 00 IP 20	IP 40 IP 00 IP 20		
Climatic type of construction	normal or climatic type of construction for ships				climatic type of construction
Environment tests	values on request				
Weight	about 0.22 kg				about 0.44 kg

Monostable 2 RH 01, 2 RH 01, 2 RH 02, 4 RH 12 all-or-nothing relays with a voltage range acc. to UIC

Relay type	2 RH 01	2 RH 02	2 RH 02	2 RH 02	4 RH 10	4 RH 12
Parameters						
rated voltages U_N	6 V to 220 V DC				12 V to 220 V DC	
Response voltage	$\leq 0,675 \times U_N$ see paragraph "All-or-nothing relays with extended voltage and temperature range"					
max. working voltage	$1,35 \times U_N$ see paragraph "All-or-nothing relays with extended voltage and temperature range"					
operating mode	continuous operation					
Dropout voltage	$\geq 5\%$ of U_N					
Ambient temperature	- 40°C up to +55°C at individual installation - 40°C up to +50°C at block installation see paragraph "All-or-nothing relays with extended voltage and temperature range"					
Rated consumption:	2.0 W \pm 15 %				4.0 W \pm 15 %	
Function indicator	without function indicator or with sign / drop indicator				without	
max. switching voltage	≤ 250 V AC/DC					
Number of contacts	4 changeover contacts				8 changeover contacts	
Contact arrangement	single contacts	twin contacts			single contacts	twin contacts
Material of contact-tip	AgCu		AgNi0,15Au6	AgPd30	AgCu	
Contact circuit resistance (24 V-, 100 mA, new condition)	approx. 30 m Ω		approx. 20 m Ω	approx. 40 m Ω	approx. 30 m Ω	
Maximum making capacity	10 A DC/AC					
Maximum permitted continuous current	5 A the sum of the square of the single currents must not exceed 64 A ²				5 A the sum of the square of the single currents must not exceed 104 A ²	
Limiting continuous current	4 A over four making contact circuits				3.6 A over eight making contact circuits	
Switching frequency	$\leq 3,600$ switching cycles per hour					
Mechanical endurance	$\geq 10 \times 10^6$ cycles		$\geq 20 \times 10^6$ switching cycles		$\geq 10 \times 10^6$ switching cycles	
• without function indication	$\geq 0,1 \times 10^6$ cycles		$\geq 0,1 \times 10^6$ switching cycles		-	
• with sign, drop indicator						
Rated breaking capacity						
• $\cos \varphi = 1.0$ 230 V AC	1.0 A	1.5 A	1.5 A	1.5 A	1.5 A	1.5 A
• $\cos \varphi = 0.4$ 230 V AC	1.0 A	1.0 A	1.0 A	1.0 A	1.0 A	1.0 A
• $\tau = 0$ ms 220 V DC	0.4 A	0.4 A	0.4 A	0.4 A	0.4 A	0.4 A
• $\tau = 40$ ms 220 V DC	0.15 A	0.1 A	0.1 A	0.05 A	0.15 A	0.1 A
• $\tau = 20$ ms 220 V DC	-	0.04 A	-	0.04 A	-	0.04 A
Minimum switching capacity	24 V-, 10 mA, $\tau = 0$ ms	12 V-, 5 mA, $\tau = 0$ ms	12 V-, 1 mA, $\tau = 0$ ms	12 V-, 25 mA, $\tau = 0$ ms	24 V-, 10 mA, $\tau = 0$ ms	12 V-, 5 mA, $\tau = 0$ ms
Voltage endurance						
• at rated breaking capacity	$\geq 2,0 \times 10^6$ (AC) $\geq 1,0 \times 10^6$ (DC)	$\geq 2,0 \times 10^6$ (AC) $\geq 1,0 \times 10^6$ (DC)	$\geq 3,0 \times 10^6$ (AC) $\geq 1,0 \times 10^6$ (DC)	$\geq 10 \times 10^6$ (AC) $\geq 2,0 \times 10^6$ (DC)	$\geq 2,0 \times 10^6$ (AC) $\geq 1,0 \times 10^6$ (DC)	$\geq 2,0 \times 10^6$ (AC) $\geq 1,0 \times 10^6$ (DC)
• at inherent load	$\geq 5,0 \times 10^6$	$\geq 5,0 \times 10^6$	$\geq 5,0 \times 10^6$	$\geq 10 \times 10^6$	$\geq 2,5 \times 10^6$	$\geq 2,5 \times 10^6$
• at minimum switching capacity	$\geq 10 \times 10^6$	$\geq 10 \times 10^6$	$\geq 10 \times 10^6$	$\geq 20 \times 10^6$	$\geq 10 \times 10^6$	$\geq 10 \times 10^6$
• response time of make contacts	≤ 25 ms				≤ 25 ms	
• without function indication	≤ 35 ms				-	
• with sign, drop indicator						
closing time of a break contact	≤ 25 ms					
• with freewheeling diode	≤ 80 ms					
Rated alternating insulation voltage	2 kV					
degree of pollution	3 acc. to DIN VDE 0110-1					
Impulse voltage withstand level	4.0 kV, voltage form 1.2/50 μ s					
Clearances in air	≥ 3 mm					
Creep age distances	≥ 4 mm					
Site altitude	$\leq 2,000$ m above sea level					
Relay enclosure	closed metal cover (Al), transparent display window					
Insulation resistance	$\geq 1 \times 10^8 \Omega$ in new condition, $U_p = 500$ V					
Degree of protection	IP40 - enclosure IP00 - connecting plug-in blades IP20 - connecting terminals with plug-in connection for quick-rail fixings					
Climatic type of construction	normal or climatic type of construction	climatic type of construction		normal or climatic type of construction for ships	climatic type of construction	
Environment tests	values on request					
Weight	about 0.22 kg				about 0.44 kg	

*The golden layer of the AgNi0,15 Au6 contact tip material is subject under erosion depending on the current value. After that the contacts have the features of silver-nickel (fine silver) contact tip material.

Monostable All-or-Nothing Relays 2 RH 01, 2 RH 30 to monitor current and navigation lamps

Specific Parameter for 2 RH 01 (DC) All-or-Nothing Relays

Use as current monitoring relays:

Rated current I_N	[A]	0,015	0,17	0,24	0,35	0,46	0,50	0,90	1,50	2,45	4,15
Minimum response current	[A]	0,012	0,14	0,20	0,27	0,35	0,42	0,72	1,17	1,97	2,59
Maximum permitted continuous current	[A]	0,020	0,24	0,35	0,48	0,61	0,75	1,25	2,11	3,61	4,69
Coil resistance	[Ω]	4107	29,3	14,1	7,3	4,55	3,04	1,08	0,38	0,13	0,077
Rated consumption:	[W]	0,92	0,85	0,81	0,89	0,96	0,76	0,87	0,86	0,78	1,33

Use as monitoring relays for lamps and navigation lamps:

Rated current	[A]	0,17	0,24	0,35	0,46	0,46	0,50	0,50	0,50	0,50	0,50	0,50	0,90	0,90
Voltage of lamp	[V]	220	220	220	110	220	24	110	110	220	220	220	24	110
Capacity of lamp	[W]	34	40	60	40	75	10	60	75	100	3x40	2x60	20	100
U_{Loss} * through relay	[V]	4,44	2,53	1,97	1,63	1,54	1,20	1,63	2,03	1,37	1,65	1,65	0,87	0,97

Specific Parameter for 2 RH 30 (AC 50 Hz) All-or-Nothing Relays

Use as monitoring relays for lamps and navigation lamps:

Rated current	[A]	0,34	0,4	0,53	0,6	0,7	0,7	0,95	0,95	0,95	0,95	0,95	1,33	1,8	1,8	1,8
Maximum permitted continuous current	[A]	0,5	0,75	0,9	1,0	1,0	1,4	1,4	1,4	1,4	1,4	1,4	1,95	2,5	2,5	2,5
Voltage of lamp	[V]	230	230	230	230	127	230	24	127	127	127	230	230	127	24	127
Capacity of lamp	[W]	34	40	60	2x40 80	40	75	10	60	75	2x40	100	2x60 3x40 120	2x40	20	100
Current at U_N	[mA]	147	173	260	347	314	326	410	471	589	628	434	521	629	827	786
U_{Loss} * through relay	[V]	6,85	5,84	5,34	5,20	3,51	3,64	2,58	2,96	3,70	3,94	2,73	3,27	1,95	1,54	1,46

General Parameter for 2 RH 01 und 2 RH 30 All-or-Nothing Relays

Parameter	Type: 2 RH 01	Type: 2 RH 30
Rated frequency F_N	-	50 Hz
Tolerance of rated frequency	-	$\pm 6\%$
operating mode	continuous operation	
Release current	$\geq 5\%$ of I_N	$\geq 15\%$ of I_N
Ambient temperature	-30°C up to +55°C at individual installation -30°C up to +50°C at block installation	
Function indicator	optionally without function indicator or with target / drop indicator	
Maximum switching voltage:	≤ 250 V AC/DC	
Number of contacts	4 changeover contacts	
Contact arrangement	single contacts	
Material of contact-tip	hard silver AgCu	
Contact circuit resistance	approx. 30 m Ω in new condition (24 V DC, 100 mA,)	
Maximum making capacity	10 A DC/AC	
Maximum permitted continuous current	5 A the sum of the square of the single currents must not exceed 64 A ²	
Limiting continuous current	4 A over all 4 making contact circuits	
Switching frequency	$\leq 3,600$ switching cycles as current monitoring relay $\leq 1,800$ cycles as lamp monitoring relay break between two cycles must be ≥ 1 s	≤ 600 switching cycles per hour break between two cycles must be ≥ 5 s
Mechanical endurance	$\geq 10 \times 10^5$ cycles without function indication $\geq 0,1 \times 10^6$ cycles with target and/or drop indicator	
Rated breaking capacity	1.5 A $\cos \varphi = 1.0$ 230 V AC 1.0 A $\cos \varphi = 0.4$ 230 V AC 0.4 A $\tau = 0$ ms 220 V DC 0.15 A $\tau = 40$ ms 220 V DC	
Minimum switching capacity	24 V DC, 10 mA, $\tau = 0$ ms	
Voltage endurance	$\geq 1,0 \times 10^6$ cycles at rated breaking capacity	
response time of make contacts	≤ 30 ms at I_N without function indication ≤ 40 ms at I_N with target and/or drop indicator	
closing time of a break contact	≤ 20 ms	
Rated alternating insulation voltage	2 kV	
degree of pollution	3 acc. to DIN VDE 0110-1	
Impulse voltage withstand level	4.0 kV, voltage form 1.2/50 μ s	
Clearances in air	≥ 3 mm	
Creep age distances	≥ 4 mm	
Site altitude	$\leq 2,000$ m above sea level	
Relay enclosure	closed metal cover (Al), transparent display window	
Insulation resistance	$\geq 1 \times 10^8 \Omega$ in new condition, $U_P = 500$ V	
Degree of protection	IP40 - enclosure IP00 - connecting plug-in blades IP20 - connecting terminals with plug-in connection for quick-rail fixings	
Climatic type of construction	normal or climatic type of construction for ships	
Environment tests	values on request	
Weight	about 0.22 kg	

Monostable 2 RH 30, 2 RH 32 All-or-Nothing Relays for Alternating Voltage

Relay type	2 RH 30		2 RH 30		2 RH 32	
Parameters	2 RH 30		2 RH 30		2 RH 32	
Rated voltages U_N	6 V up to 230 V AC					
Rated frequency F_N	50 Hz		60 Hz		50 Hz	
Tolerance of rated frequency	$\pm 6\%$		$\pm 6\%$		$\pm 6\%$	
Response voltage	$\leq 0,8 \times U_N$					
max. working voltage	$1,1 \times U_N$					
operating mode	continuous operation					
Dropout voltage	$\geq 15\%$ of U_N					
Ambient temperature	-40°C up to +55°C at individual installation -40°C up to +50°C at block installation					
Rated consumption: • initial state • Operated condition	7.0 VA, $\cos \varphi = 0.32$ 3.6 VA, $\cos \varphi = 0.62$	7.5 VA, $\cos \varphi = 0.3$ 4.5 VA, $\cos \varphi = 0.6$	7.0 VA $\cos \varphi = 0.32$ 3.5 VA $\cos \varphi = 0.62$			
Function indicator	with or without target and/or drop indicator					with or without target
max. switching voltage	≤ 250 V AC/DC					
Number of contacts	4 changeover contacts					
Contact arrangement	single contacts				twin contacts	
Material of contact-tip	AgCu					
Contact circuit resistance	approx. 30 mΩ (24 V DC, 100 mA, new condition)					
Maximum making capacity	10 A DC/AC			3 A DC/AC		10 A DC/AC
Maximum permitted continuous current	5 A the squares of the single currents must not exceed the sum 64 A ²			3 A the squares of the single currents must not exceed the sum of 9 A		5 A, the squares of the single currents must not exceed in single installation 64 A ² , in block installation 9 A ²
Limiting continuous current (over four making contact circuits)	4 A			1.5 A		4.0 A at single installation 1.5 A at block installation
Switching frequency	$\leq 3,600$ switching cycles per hour					$\leq 1,200$ cycles per hour
Mechanical endurance	$\geq 10 \times 10^6$ cycles without function indication $\geq 0,1 \times 10^6$ cycles without function indication					
Rated breaking capacity • $\cos \varphi = 1.0$ 230 V AC • $\cos \varphi = 0.4$ 230 V AC • $\tau = 0$ ms 220 V DC • $\tau = 40$ ms 220 V DC	1.5 A 1.0 A 0.4 A 0.15 A				1.5 A 1.0 A 0.4 A 0.1 A	
Minimum switching capacity	24 V-, 10 mA, $\tau = 0$ ms				12 V-, 5 mA, $\tau = 0$ ms	
Voltage endurance • at rated breaking capacity • at inherent load • at minimum switching capacity	$\geq 2,0 \times 10^6$ (AC) $\geq 1,0 \times 10^6$ (DC) $\geq 5,0 \times 10^6$ $\geq 10 \times 10^6$				$\geq 1,0 \times 10^6$ (AC) $\geq 1,0 \times 10^6$ (DC) $\geq 2,5 \times 10^6$ $\geq 10 \times 10^6$	
response time of make contacts • without function indication • with sign, drop indicator	≤ 20 ms ≤ 30 ms					
closing time of a break contact	≤ 20 ms					
Rated alternating insulation voltage	2 kV					
degree of pollution	3 acc. to DIN VDE 0110-1					
Impulse voltage withstand level	4.0 kV, voltage form 1.2/50 μs					
Clearances in air	≥ 3 mm					
Creep age distances	≥ 4 mm					
Site altitude	$\leq 2,000$ m above sea level					
Relay enclosure	bifurcated PC cover, transparent	closed metal cover (Al) transparent display window			closed plastic covers (PC), transparent	
Insulation resistance	$\geq 1 \times 10^8$ Ω in new condition, $U_P = 500$ V					
Degree of protection • casing • Connecting plug-in blades • terminal with plug-in connection for quick-rail fixings	IP 40 IP 00 IP 20					IP 50 IP 00 IP 20
Climatic type of construction	normal or climatic type of construction for ships					climatic type of construction
Environment tests	values on request					
Weight	about 0.22 kg					

Monostable 4 RH 40, 4 RH 42 All-or-Nothing Relays for Alternating Voltage

Relay type	4 RH 40		4 RH 40	4 RH 42
Parameters				
rated voltages U_N	12 V up to 230 V AC			
Rated frequency F_N	50 Hz		60 Hz	50 Hz
Tolerance of rated frequency	$\pm 6\%$		$\pm 6\%$	$\pm 6\%$
Response voltage	$\leq 0,8 \times U_N$			
max. working voltage	$1,1 \times U_N$			
operating mode	continuous operation			
Dropout voltage	$\geq 15\%$ of U_N			
Ambient temperature • at single installation • at block installation	-40°C up to +55°C -40°C up to +50°C		-40°C up to +50°C -40°C up to +45°C	-40°C up to +55°C -40°C up to +50°C
Rated consumption: • initial state • Operated condition	14 VA $\cos \varphi = 0.32$ 7.2 VA $\cos \varphi = 0.62$		15 VA $\cos \varphi = 0.3$ 9 VA $\cos \varphi = 0.6$	14 VA $\cos \varphi = 0.32$ 7.2 VA $\cos \varphi = 0.62$
Function indicator	without			
max. switching voltage	≤ 250 V AC/DC			
Number of contacts	8 changeover contacts			
Contact arrangement	single contacts			twin contacts
Material of contact-tip	AgCu			
Contact circuit resistance	approx. 30 m Ω new condition (24 V DC, 100 mA)			
Maximum making capacity	10 A DC/AC			
Maximum permitted continuous current	5 A, the squares of the single currents must not exceed the sum 98 A ²		5 A, the squares of the single currents must not exceed the sum of 98 A ² at single installation, and 46 A ² at block installation	5 A, the sum of the square of the single currents must not exceed 98 A ²
Limiting continuous current	3.5 A (over eight making contact circuits)		3.5 A at single installation 2.4 A at block installation (over eight making contact circuits)	3.5 A (over eight making contact circuits)
Switching frequency	$\leq 3,600$ cycles per hour			
Mechanical endurance	$\geq 10 \times 10^6$ switching cycles			
Rated breaking capacity • $\cos \varphi = 1.0$ 230 V AC • $\cos \varphi = 0.4$ 230 V AC • $\tau = 0$ ms 220 V DC • $\tau = 40$ ms 220 V DC		1.5 A 1.0 A 0.4 A 0.15 A		1.5 A 1.0 A 0.4 A 0.10 A
Minimum switching capacity	24 V-, 10 mA, $\tau = 0$ ms			12 V-, 5 mA, $\tau = 0$ ms
Voltage endurance • at rated breaking capacity • at inherent load • at minimum switching capacity		$\geq 2,0 \times 10^6$ (AC) $\geq 1,0 \times 10^6$ (DC) $\geq 5,0 \times 10^6$ $\geq 10 \times 10^6$		$\geq 1,0 \times 10^6$ (AC) $\geq 1,0 \times 10^6$ (DC) $\geq 5,0 \times 10^6$ $\geq 10 \times 10^6$
response time of make contacts	≤ 25 ms			
closing time of a break contact	≤ 25 ms			
Rated alternating insulation voltage	2 kV			
degree of pollution	3 acc. to DIN VDE 0110-1			
Impulse voltage withstand level	4.0 kV, voltage form 1.2/50 μ s			
Clearances in air	≥ 3 mm			
Creep age distances	≥ 4 mm			
Site altitude	$\leq 2,000$ m above sea level			
Relay enclosure	closed metal cover (Al), transparent display window			
Insulation resistance	$\geq 1 \times 10^8 \Omega$ in new condition, $U_P = 500$ V			
Degree of protection	IP40 - enclosure IP00 - connecting plug-in blades IP20 - connecting terminals with plug-in connection for quick-rail fixings			
Climatic type of construction	normal or climatic type of construction for ships			climatic type of construction
Environment tests	values on request			
Weight	about 0.44 kg			

Bistable RH 60, 2 RH 62 All-or-Nothing Relays (Remanence relays)

Relay type	2 RH 60		2 RH 62											
Parameters														
rated voltages U_N	6 V to 220 V DC													
Response voltage	$\leq 0,8 \times U_N$													
max. working voltage	$1,1 \times U_N$													
Rated consumption:	≤ 2.5 W at excitation ≤ 0.5 W at negative excitation over R_V													
Resistance values $R_V (\geq 2$ W) for the negative excitation (included in the scope of delivery)	U_N [V]	6	12	24	32	36	42	48	60	80	100	110	125	220
	R_V [k Ω]	0,082	0,33	1,2	2,2	2,7	3,9	5,6	8,2	15	22	27	33	100
operating mode	pulse or continuous operation (excitation, negative excitation)													
Ambient temperature	-30°C up to +55°C at individual installation -30°C up to +50°C at block installation -30°C up to +70°C at pulse operation, pulse time approx. 100 ms													
Function indicator	optionally without function indicator or with target													
Maximum switching voltage:	≤ 250 V AC/DC													
Number of contacts	4 changeover contacts													
Contact arrangement	single contacts						twin contacts							
Material of contact-tip	hard silver AgCu													
Contact circuit resistance	approx. 30 m Ω in new condition (24 V DC, 100 mA,)													
Maximum making capacity	10 A DC/AC													
Maximum permitted continuous current	5 A at continuous operation, the sum of squares of the single currents must not exceed 64 A ² at single installation, at block installation they must not exceed 23 A ² , at pulse operation they must not exceed 100 A ² ,													
Limiting continuous current (over four make contacts)	5 A at block installation and pulse operation 4 A at single installation and permanent closing 2,4 A at block installation and permanent closing													
Switching frequency	≤ 600 cycles per hour													
Mechanical endurance	$\geq 10 \times 10^6$ cycles without function indication $\geq 0,1 \times 10^6$ cycles with target													
Rated breaking capacity • $\cos \varphi = 1.0$ 230 V AC • $\cos \varphi = 0.4$ 230 V AC • $\tau = 0$ ms 220 V DC • $\tau = 40$ ms 220 V DC	1.5 A 1.0 A 0.4 A 0.15 A						1.5 A 1.0 A 0.4 A 0.10 A							
Minimum switching capacity	24 V DC, 10 mA, $\tau = 0$ ms						12 V DC, 5 mA, $\tau = 0$ ms							
Voltage endurance • at rated breaking capacity • at inherent load • at minimum switching capacity	$\geq 2,0 \times 10^6$ (AC) $\geq 1,0 \times 10^6$ (DC) $\geq 2,5 \times 10^6$ $\geq 10 \times 10^6$													
response time of make contacts	≤ 25 ms without function indicator ≤ 35 ms with target													
closing time of a break contact	≤ 30 ms													
Pulse duration at pulse operation	≥ 100 ms ≥ 100 ms													
Rated alternating insulation voltage	2 kV													
degree of pollution	3 acc. to DIN VDE 0110-1													
Impulse voltage withstand level	kV	4.0 kV, voltage form 1.2 / 50 μ s, at negative excitation over R_V 2												
Clearances in air	≥ 3 mm													
Creep age distances	≥ 4 mm													
Site altitude	$\leq 2,000$ m above sea level													
Relay enclosure	bifurcated plastic covers (PC), transparent													
Insulation resistance	$\geq 1 \times 10^8 \Omega$ in new condition, $U_P = 500$ V													
Degree of protection	IP40 - enclosure IP00 - connecting plug-in blades IP20 - connecting terminals with plug-in connection for quick-rail fixings													
Climatic type of construction	Normal type of construction													
Environment tests	values on request													
Weight	about 0.22 kg													

RELOG Plug-In Connection with Screw Terminal for Quick-Rail Fastening and/or Screw Fastening over Fastening Sheet

For all-or-nothing relays of the 2 RH ..., 4 RH type, the plug-in connections allow to accomplish a screw terminal connection while maintaining their plug ability.

The plug-in connections are available in the following types:

- construction with labeling of connections in DIN standards
- construction with labeling of connections in RELOG standards
- construction without diode
- construction with diode between the terminals A 1 (1.7) – cathode and A2 (3.7) – anode.

The plug-in connection is mounted either by snapping onto a rail acc. to DIN EN 50022, or by single arrangement on a fastening sheet that can be supplied as a separate part.

When using plug-in connections for the type 4 RH 10, 4 RH 12, 4 RH 40, 4 RH 42 relays, two plug-in connections have to be installed.

Parameters:

Rated voltage:	250-volt
Rated insulation alternating voltage:	2 kV, 50 Hz (construction without free-wheeling diode)
Rated surge voltage:	3.6 kV, voltage form 1.2/50 μ s
Over voltage category:	III
Degree of pollution:	3
Clearances in air:	≥ 2.5 mm
Creep age distances:	≥ 4 mm
Site altitude:	2,000 m above sea level
Ambient temperature:	-40°C up to +55°C at single installation: -40°C up to +50°C at block installation
Limiting continuous current:	4 A
Maximum permissible continuous current:	5 A
Number and type of connections:	14 terminals, tensile frame construction with solid wire protection protective-conductor terminal
Connectable conductor sizes:	1 \times 0.5 mm ² up to 1 \times 2.5 mm ² Cu single and multicore 1 \times 1.0 mm ² up to 1 \times 2.5 mm ² Cu finely stranded
Degree of protection:	IP 20
Assembly:	Snapping onto mounting rail according to DIN EN 50022-35 \times 7.5
Weight:	about 0.12 kg

RELOG Adapter with screw-type terminal for screw fixings at massive walls or switchboards

For all-or-nothing relays of the 2 RH .. , or 4 RH .. type, the adaptors allow to accomplish a screw terminal connection while maintaining the plug ability. The RELOG adaptors are available in the following types:

- wired type for an all-or-nothing relay of the 2 RH type. .
- not-wired with included accessories for individual suppressor circuit for maximum 2 all-or-nothing relays of the 2 RH type. . or 1 all-or-nothing relay of the 4 RH type. . (Attention, only 14 terminals are available!)

This offers a variety of possibilities to connect the functions of the all-or-nothing relays contained in the RELOG system.

For in- and outputs, a maximum of 14 terminals is available plus a M 3.5 protective-conductor terminal. The installation of the adaptor with screw-type terminal can be accomplished at massive walls or boards.

Parameters:

Rated voltage:	250-volt
Rated insulation alternating voltage:	2 kV, 50 Hz
Rated surge voltage:	4 kV, voltage form 1.2/50 μ s
Over voltage category:	III
degree of pollution:	3
Clearances in air:	≥ 3 mm
Creep age distances:	≥ 4 mm
Site altitude:	2,000 m above sea level
Ambient temperature:	-40°C up to +55°C
Limiting continuous current:	5 A
Maximum permissible continuous current:	5 A
Number and type of connections:	14 box-type terminals with self-releasing wire protection 1 protective-conductor terminal with M 3.5 mm cylinder head terminal point
Connectable conductor sizes:	1 \times 0.5 mm ² up to 1 \times 4,0 mm ² Cu single and multicore 1 \times 0.5 mm ² up to 1 \times 2.5 mm ² Cu finely stranded
Degree of protection:	IP 20 with terminal cover IP 00 without terminal cover
Assembly:	Screw fastening with 2 cylinder head screws with maximum M4
Weight:	about 0.2 kg

Plug-in Connections for Solder or Wire-Wrap Termination

For RELOG all-or-nothing relays of the 2 RH .. ,and 4 RH .. type, the plug-in connections allow to accomplish a solder or wire-wrap termination while maintaining the plug ability.

The plug-in connections are available in the following types:

- type with solder termination lugs; the connection is done by soldering the solder lugs
- type with wire-wrap lugs; the connection is done by fastening the wire onto the wire lugs (connecting wires can also be soldered to the wire-wrap lugs)

The plug-in connection is either mounted onto switchboards with appropriate cutouts, or onto rails using by applying screw fixings.

When using the plug-in connection for the type 4 RH 10, 4 RH 12, 4 RH 40, 4 RH 42 RELOG relays, two plug-in connections have to be installed side by side at a horizontal distance of 30 mm.

A connection for the series circuits of both coils has to be accomplished between the two plug-in connections (relay A, terminal 3.7 to relay B, terminal 1.7).

When mounting the supply leads it has to be taken into account for all terminal types that the permitted creeping and air distances are observed according to DIN EN 60810-5 / VDE 0435 Part 140: 1999-04.

Parameters:

Rated voltage:	250-volt
Rated insulation alternating voltage:	2.5 kV, 50 Hz
Rated surge voltage:	4 kV, voltage form 1.2/50 µs
Over voltage category:	III
degree of pollution:	3
Clearances in air:	≥ 3 mm
Creep age distances:	≥ 4 mm
Site altitude:	2,000 m above sea level
Ambient temperature:	-40°C up to + 55°C
Limiting continuous current:	5 A
Maximum permissible continuous current:	5 A
Number of terminals:	14 + 2 protective-conductor terminals (necessary for relays with metal cover) 22 + 2 protective-conductor terminals (necessary for relays with metal cover)
Construction types of terminals:	soldering lugs for wire diameters up to ∅ 1,2 mm wire-wrap lugs with rectangular section 1.0 mm x 1.6 mm Protective-conductor terminals are basically performed as solder terminations.
Connectable supply leads:	0,5. mm² up to 1 mm² at solder termination types 1 terminal ∅ 0,6 mm up to ∅ 0,8 mm Cu at wire termination types
Degree of protection:	IP 00 terminal end IP 30 mating side IP 40 mating side with all-or-nothing relay
Assembly:	Screw fastening with 2 cylinder head screws with maximum M3
Assembly distances:	minimum distance horizontally from center to center of plug-in connection ≥ 30 mm minimum distance vertically from center to center of plug-in connection ≥ 105 mm
weight:	about 0.04 kg

Diagrams

RELOG 2 RH 01 / 2 RH 30 All-or-Nothing Relay (PC cover)

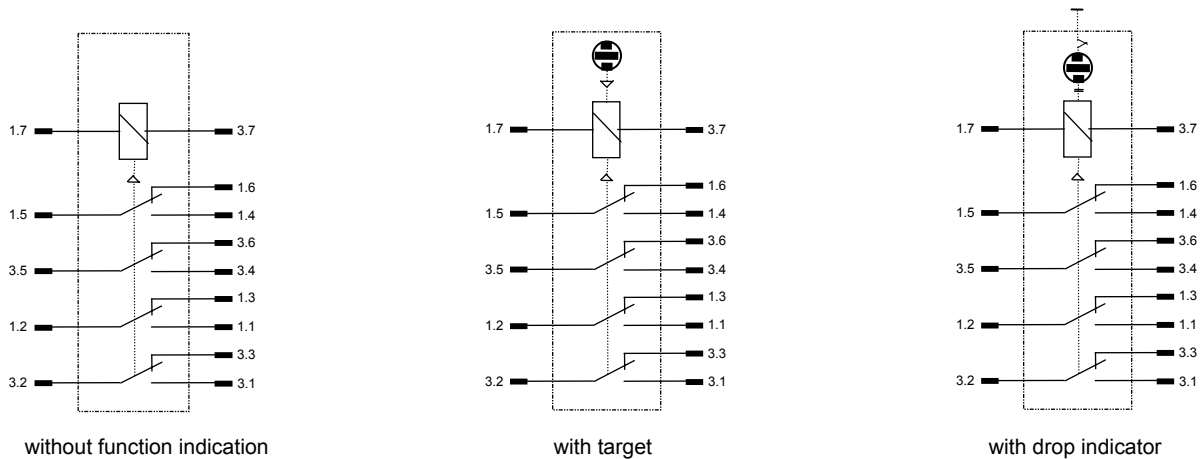

RELOG 2 RH 01 All-or-Nothing Relay, Diode Type (PC cover)

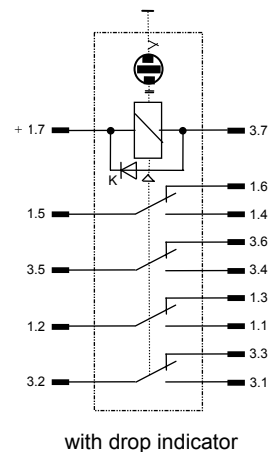
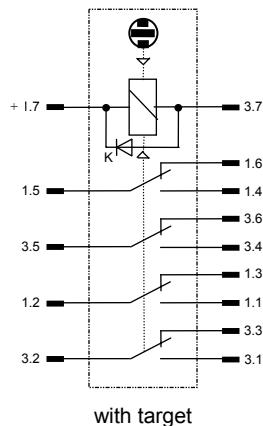
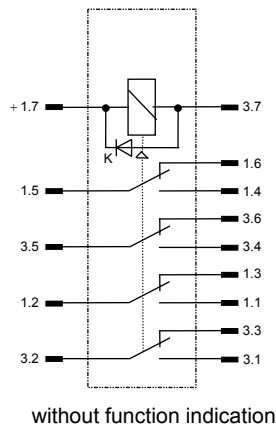

RELOG 2 RH 02 / 2 RH 32 All-or-Nothing Relay (PC cover)

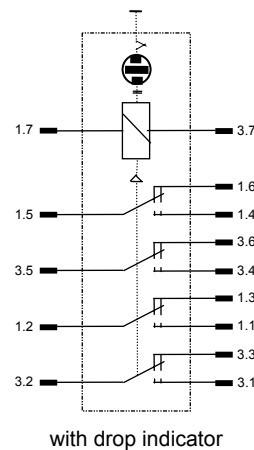
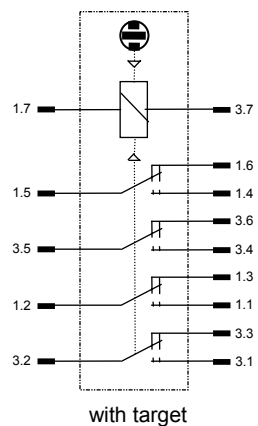
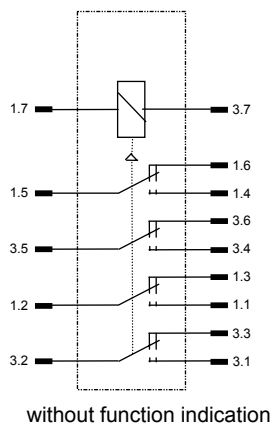

RELOG 2 RH 02 All-or-Nothing Relay, Diode Type (PC cover)

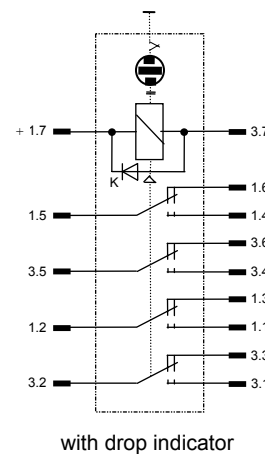
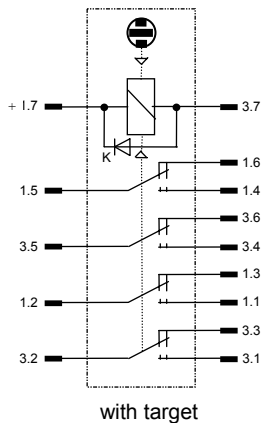
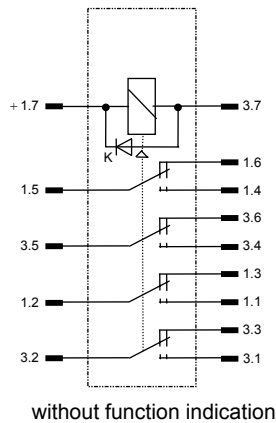

RELOG 2 RH 01 All-or-Nothing Relay UIC Type, 2 RH 01/2 RH 30 Current Type 50 Hz, 2 RH 30 50Hz, 60 Hz (AI cover)

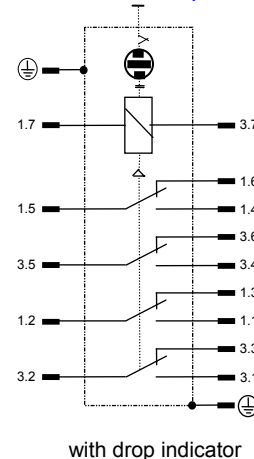
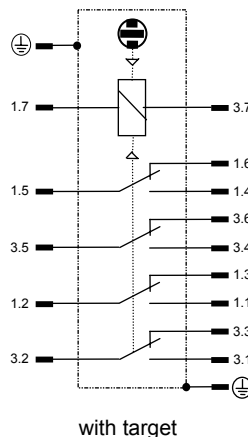
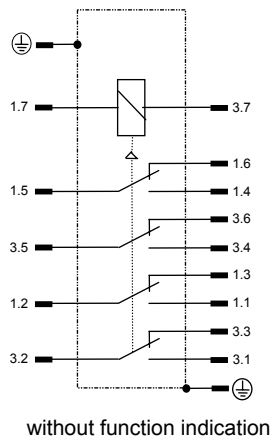

RELOG 2 RH 02 All-or-Nothing Relay, UIC Type (AI cover)

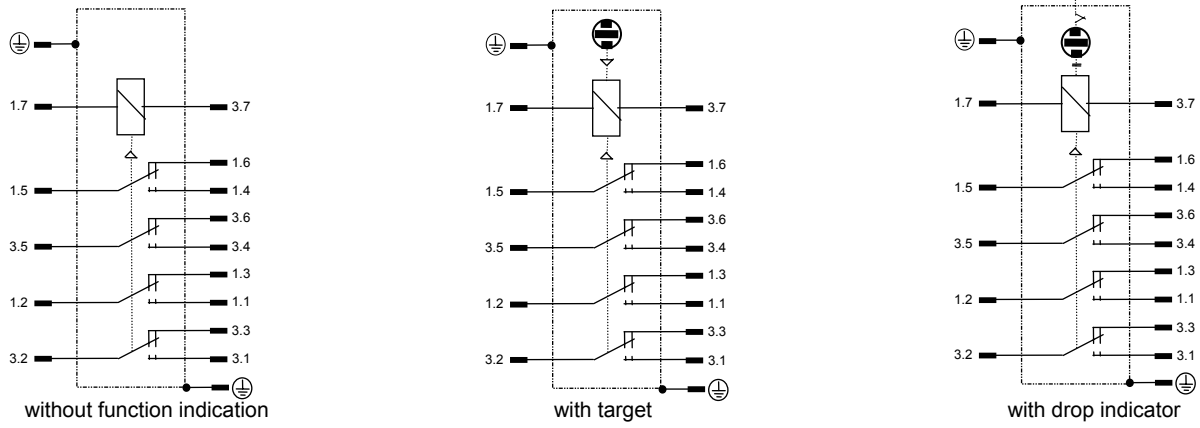

RELOG 2 RH 60 Bistable All-or-Nothing Relay (PC cover)

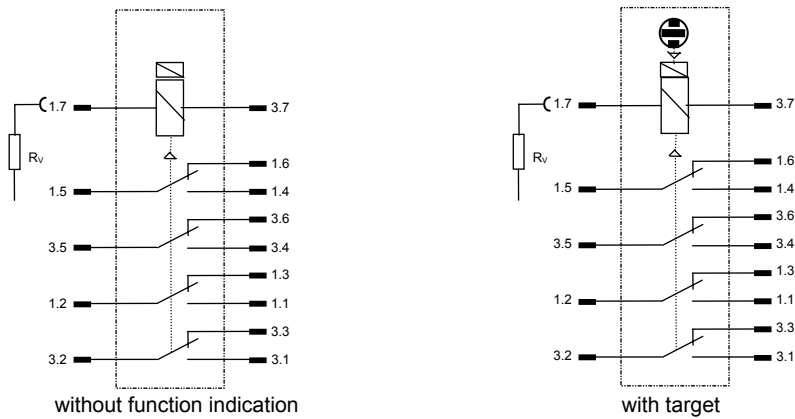

RELOG 2 RH 62 Bistable All-or-Nothing Relay (PC cover)

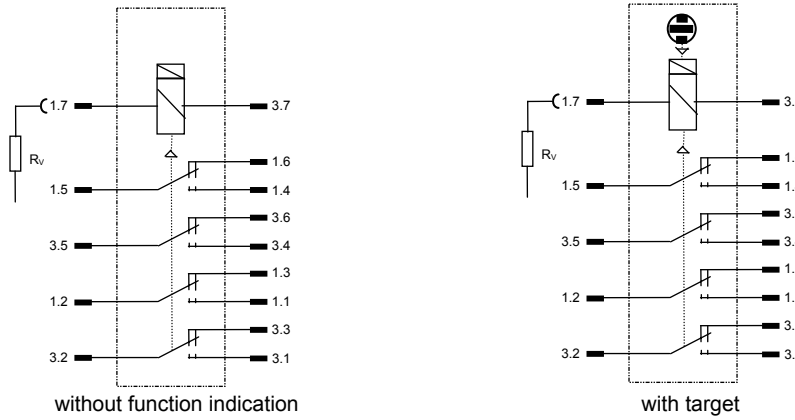

RELOG 4 RH 10 / 4 RH 40 All-or-Nothing Relay (AI cover)

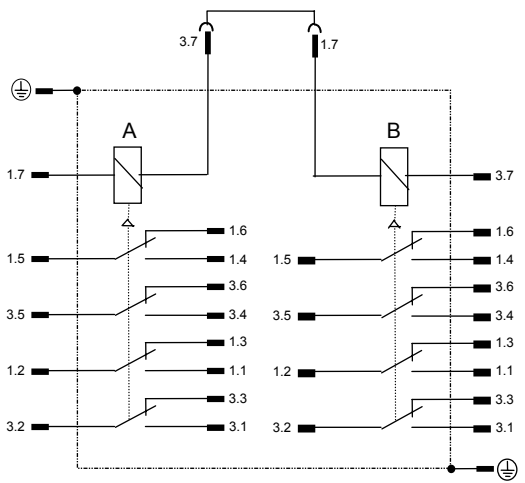

RELOG 4 RH 12 / 4 RH 42 All-or-Nothing Relay (AI cover)

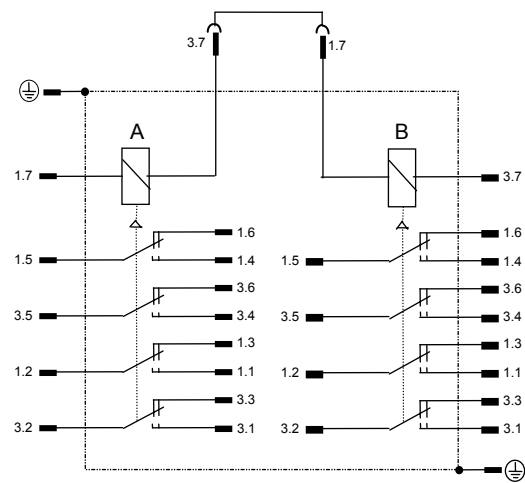

RELOG Plug-In Connection for Quick-Rail Fixing with screw-type terminal provided with 2 RH. . Relay

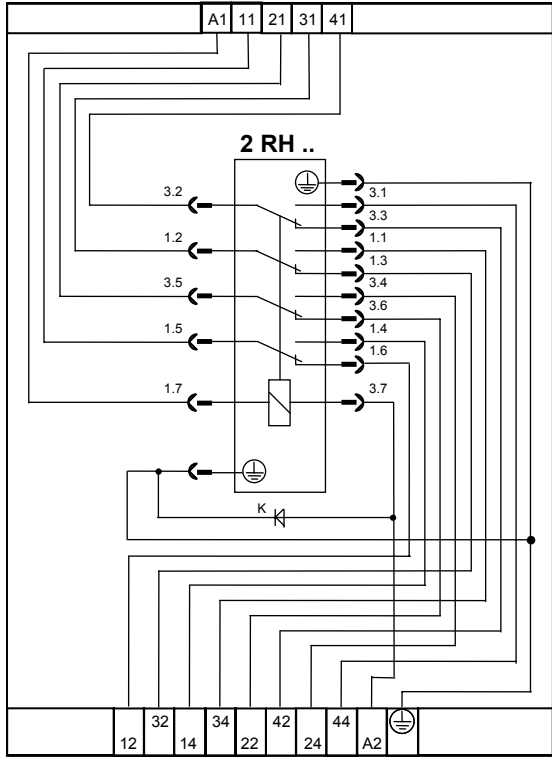

Diagram Rs 802 338 (type with free-wheeling diode)
Labeling acc. to German DIN standard

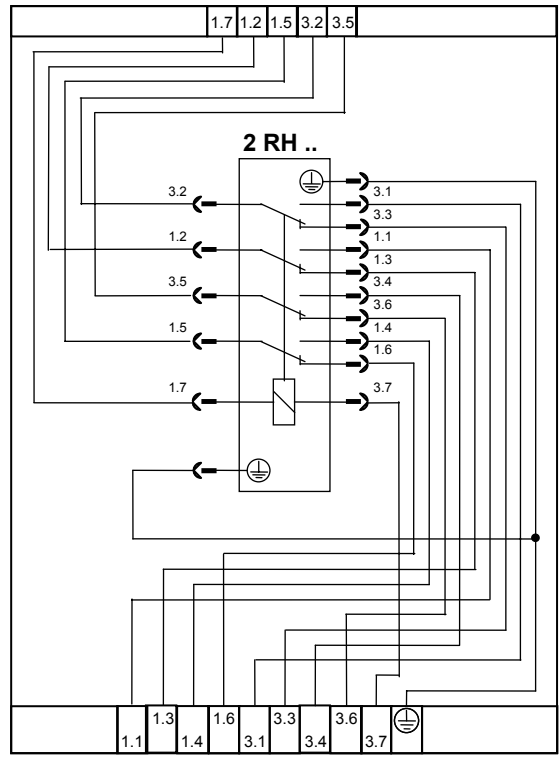
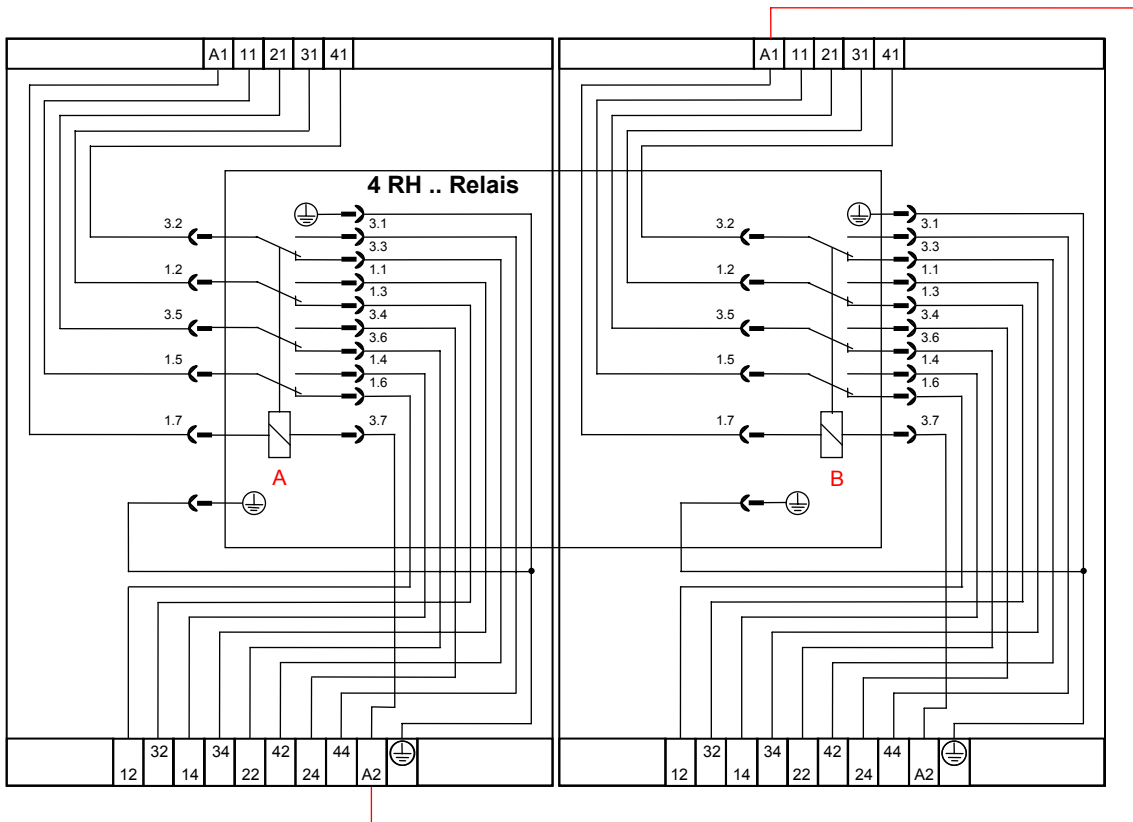

Diagram Rs 802 339 (type without free-wheeling diode)
Labeling acc. to RELOG standard

RELOG Plug-In Connection for Quick-Rail Fixing with screw-type terminal provided with 4 RH. . Relay



Wiring diagram for RELOG all-or-nothing relays: 4 RH 10 / 4 RH 12 / 4 RH 40 / 4 RH 42
with 2 RELOG plug-in connections for quick-rail fixing (DIN labeling, without free-wheeling diode)

RELOG Adaptor Diagram for 2 RH. . All-or-Nothing Relay

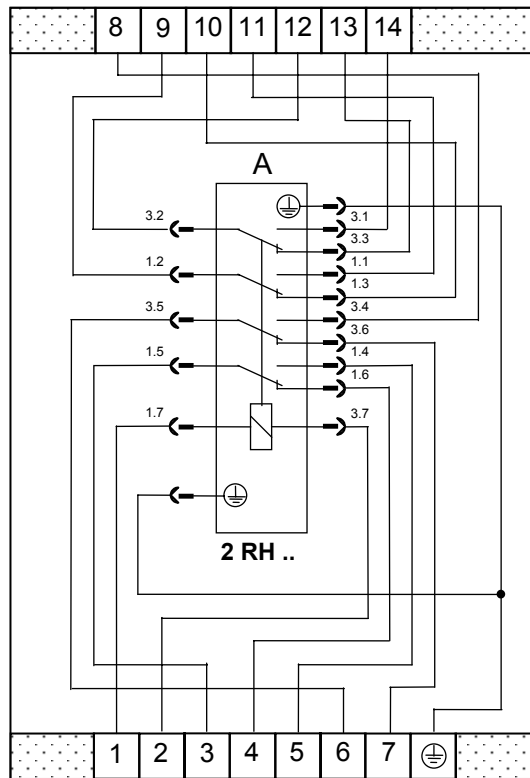

Circuit diagram Rs 801487

Dimensioned drawings

RELOG All-or-Nothing Relays 2 RH 01, 2 RH 02, 2 RH 30, 2 RH 32

RELOG All-or-Nothing Relay 2 RH 60, 2 RH 62

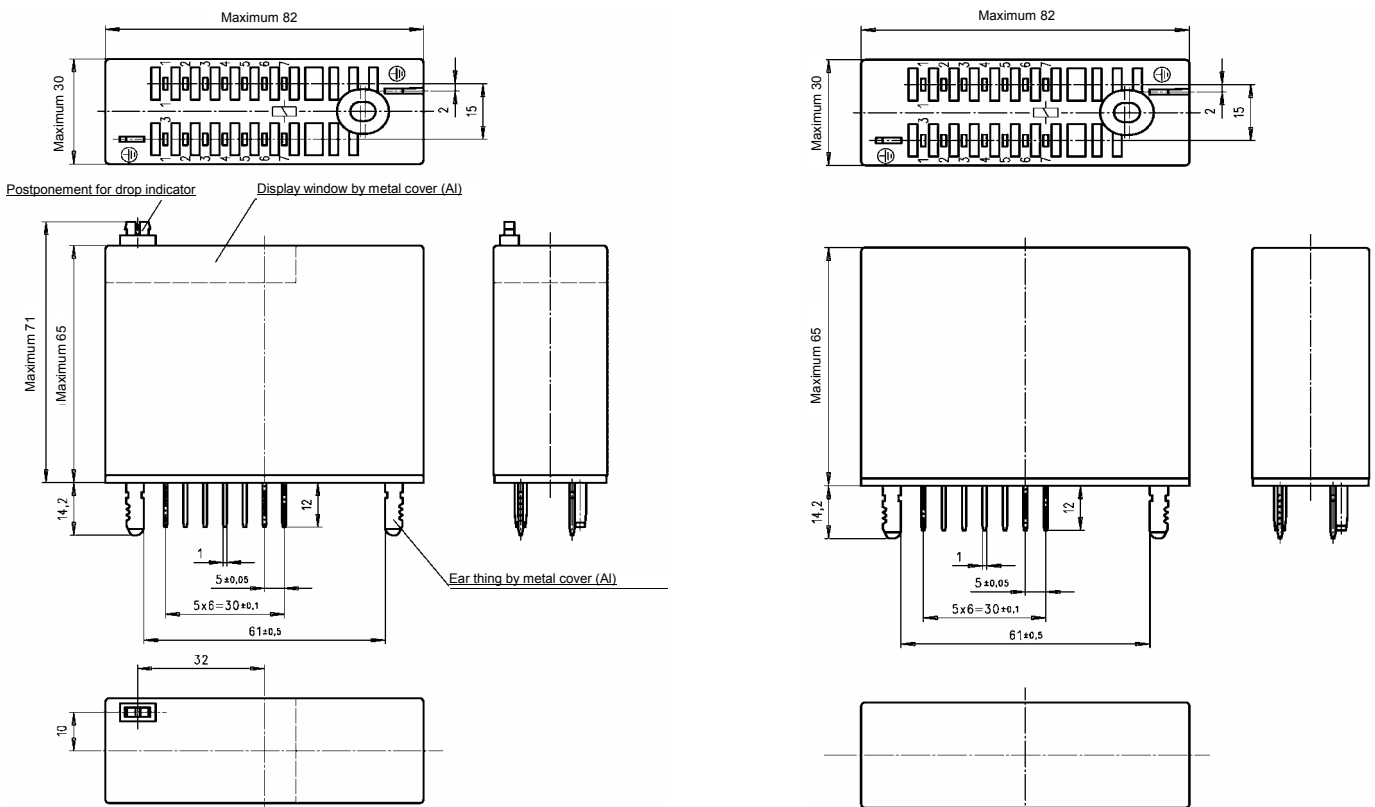

Dimensioned drawing Rs 805,540

RELOG All-or-Nothing Relays 4 RH 10, 4 RH 12, 4 RH 40, 4 RH 42 RELOG 2 RH 02, 2 RH 32 All-or-Nothing Relay (IP 50)

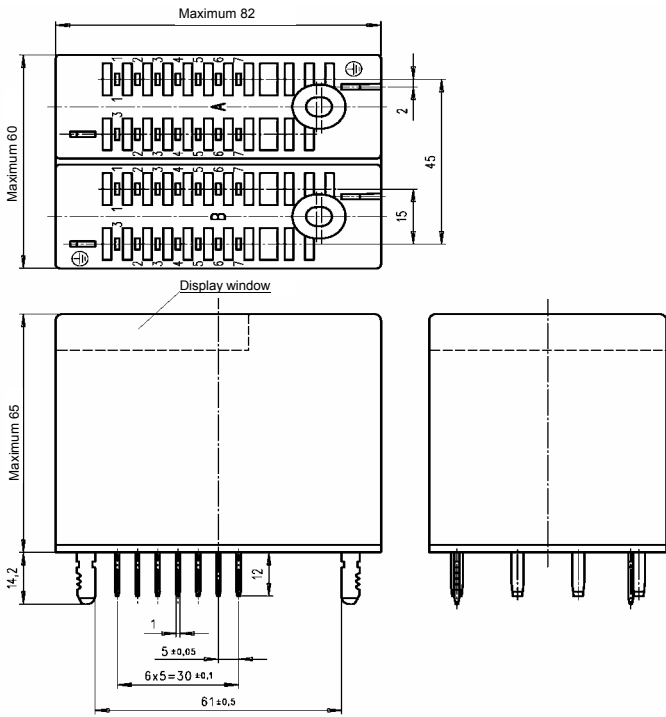

Dimensioned drawing Rs 805543

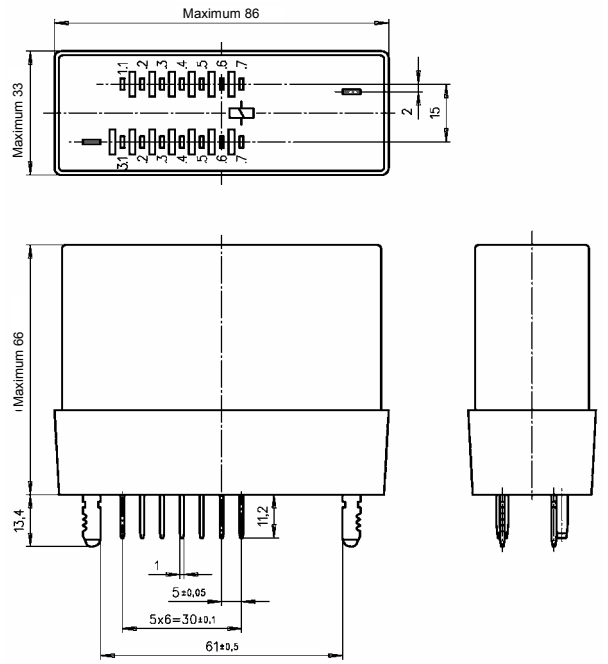

Dimensioned drawing Rs 805495

RELOG Plug-In Connection for Quick-Rail Fastening and/or Fastening Sheet with Screw Termination

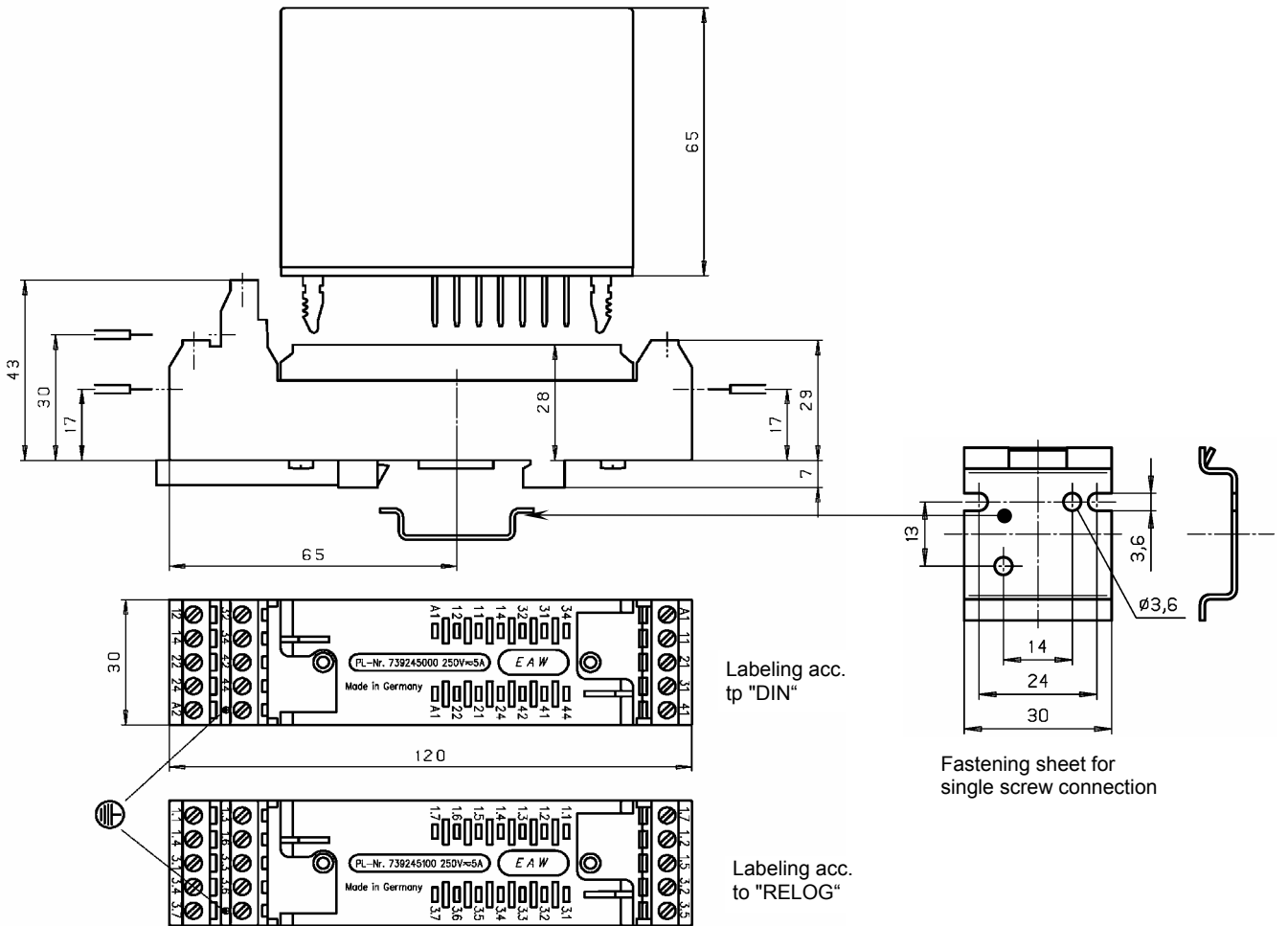

Dimensioned drawing Rs 805042

RELOG – Adaptor for 2 RH .. and/or 4 RH .. All-or-Nothing Relav

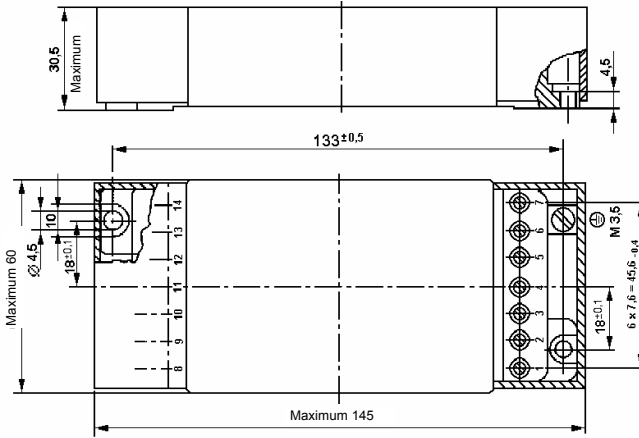

Dimensioned drawing Rs 805541

RELOG Plug-In Connections, Solder Termination Type

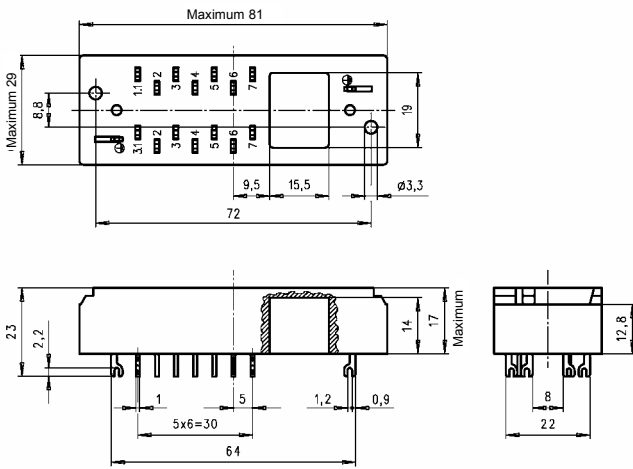

Dimensioned drawing Rs 805 202 Sheet 01; 14 poles

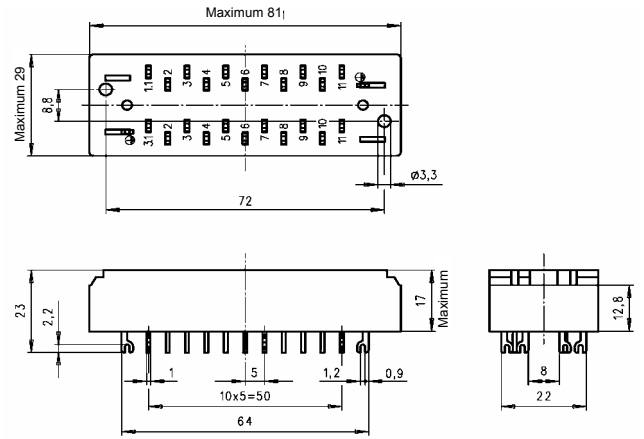

Dimensioned drawing Rs 805 202 Sheet 02; 22 poles

RELOG Plug-In Connections, Wire-Wrap Termination Type

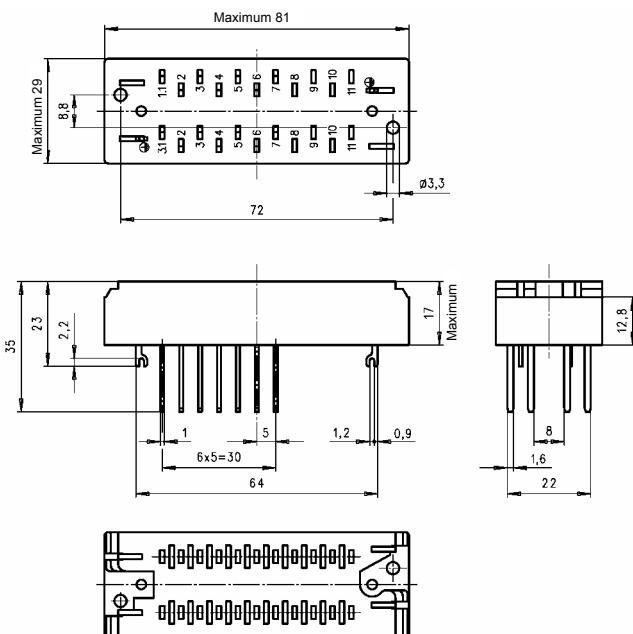

Dimensioned drawing Rs 805255 Sheet 01; 14 poles

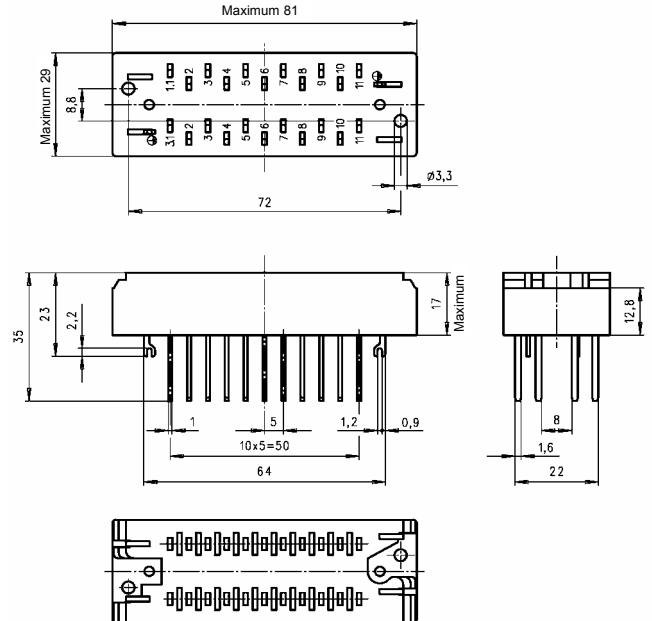

Dimensioned drawing Rs 805255 Sheet 02; 22 poles

List of Order Numbers (Pl. Nos.)

RELOG 2 RH 01 All-or-Nothing Relay Types:

DC, 4 changeover contacts, single contacts, AgCu, bifurcated cover, IP 40, standard type

12 volt-	1 732 691 000
24 volt-	1 732 692 000
60 volt-	1 732 693 000
110 volt-	1 732 694 000
220 volt-	1 732 695 000
Special voltages	1 732 696 0 . .

DC, 4 changeover contacts, single contacts, AgCu, bifurcated cover, IP 40 target: operating current, standard type

12 volt-	1 732 703 000
24 volt-	1 732 704 000
60 volt-	1 732 705 000
110 volt-	1 732 706 000
220 volt-	1 732 707 000
Special voltages	1 732 708 0 . .

DC, 4 changeover contacts, single contacts, AgCu, bifurcated cover, IP 40 target: closed-circuit, current, standard type

12 volt-	1 732 709 000
24 volt-	1 732 710 000
60 volt-	1 732 711 000
110 volt-	1 732 712 000
220 volt-	1 732 713 000
Special voltages	1 732 714 0 . .

DC, 4 changeover contacts, single contacts, AgCu, bifurcated cover, IP 40, drop indicator, standard type

12 volt-	1 732 697 000
24 volt-	1 732 698 000
60 volt-	1 732 699 000
110 volt-	1 732 700 000
220 volt-	1 732 701 000
Special voltages	1 732 702 0 . .

DC, 4 changeover contacts, single contacts, AgCu, bifurcated cover, IP 40, climatic / ship type

12 volt-	1 771 533 000
24 volt-	1 771 534 000
60 volt-	1 771 535 000
110 volt-	1 771 536 000
220 volt-	1 771 537 000
Special voltages	1 771 538 0 . .

DC, 4 changeover contacts, single contacts, AgCu, bifurcated cover, IP 40, target operating current, climatic / ship type

12 V-	1 771 545 000
24 V-	1 771 546 000
60 V-	1 771 547 000
110 V-	1 771 548 000
220 V-	1 771 549 000
Special voltages	1 771 500 0 . .

DC, 4 changeover contacts, single contacts, AgCu, bifurcated cover, IP 40, target closed-circuit current, climatic / ship type

12 V-	1 771 551 000
24 V-	1 771 552 000
60 V-	1 771 553 000
110 V-	1 771 554 000
220 V-	1 771 555 000
Special voltages	1 771 556 0 . .

DC, 4 changeover contacts, single contacts, AgCu, bifurcated cover, IP 40, drop indicator, climatic / ship type

12 V-	1 771 539 000
24 V-	1 771 540 000
60 V-	1 771 541 000
110 V-	1 771 542 000
220 V-	1 771 543 000
Special voltages	1 771 544 0 . .

DC, 4 changeover contacts, single contacts, AgCu, bifurcated cover, IP 40, GP02-40 diode, climatic / ship type

12 V-	1 774 018 000
24 V-	1 774 019 000
60 V-	1 774 020 000
110 V-	1 774 021 000
220 V-	1 774 022 000
Special voltages	1 774 023 0 . .

DC, UIC, four changeover contacts, single contacts, AgCu, closed Al cover, IP 40, standard type

12 volt-	1 731 504 500
24 volt-	1 731 505 500
60 volt-	1 731 506 500
110 volt-	1 731 507 500
220 volt-	1 731 508 500
Special voltages	1 731 509 5 . .

DC, UIC, four changeover contacts, single contacts, AgCu, closed Al cover, IP 40, climatic type

12 volt-	1 770 328 500
24 volt-	1 770 329 500
60 volt-	1 770 330 500
110 volt-	1 770 331 500
220 volt-	1 770 332 500
Special voltages	1 770 333 5 . .

DC, UIC, four changeover contacts, single contacts, AgCu, closed Al cover, IP 40, target: operating current, climatic type

12 V-	1 770 322 500
24 V-	1 770 323 500
60 V-	1 770 324 500
110 V-	1 770 325 500
220 V-	1 770 326 500
Special voltages	1 770 327 5 . .

DC, UIC, four changeover contacts, single contacts, AgCu, closed Al cover, IP 40, target: closed-circuit current, climatic type

12 V-	1 770 316 500
24 V-	1 770 317 500
60 V-	1 770 318 500
110 V-	1 770 319 500
220 V-	1 770 320 500
Special voltages	1 770 321 5 . .

DC, UIC, four changeover contacts, single contacts, AgCu, closed Al cover, IP 40, drop indicator, climatic type

12 V-	1 770 334 500
24 V-	1 770 335 500
60 V-	1 770 336 500
110 V-	1 770 337 500
220 V-	1 770 338 500
Special voltages	1 770 339 5 . .

DC, 4 changeover contacts, single contacts, AgCu, closed Al cover, IP 40, standard type

12 volt-	1 731 504 000
24 volt-	1 731 505 000
60 volt-	1 731 506 000
110 volt-	1 731 507 000
220 volt-	1 731 508 000
Special voltages	1 731 509 0 . .

DC, 4 changeover contacts, single contacts, AgCu, closed Al cover, IP 40 target: operating current, standard type

12 volt-	1 731 484 000
24 volt-	1 731 485 000
60 volt-	1 731 486 000
110 volt-	1 731 487 000
220 volt-	1 731 488 000
Special voltages	1 731 489 0 . .

DC, 4 changeover contacts, single contacts, AgCu, closed AI cover, IP 40, standard type

12 volt-	1 731 504 000
24 volt-	1 731 505 000
60 volt-	1 731 506 000
110 volt-	1 731 507 000
220 volt-	1 731 508 000
Special voltages	1 731 509 0 . .

DC, 4 changeover contacts, single contacts, AgCu, closed AI cover, IP 40 target: operating current, standard type

12 volt-	1 731 484 000
24 volt-	1 731 485 000
60 volt-	1 731 486 000
110 volt-	1 731 487 000
220 volt-	1 731 488 000
Special voltages	1 731 489 0 . .

DC, 4 changeover contacts, single contacts, AgCu, closed AI cover, IP 40 target: closed-circuit, current, standard type

12 volt-	1 731 474 000
24 volt-	1 731 475 000
60 volt-	1 731 476 000
110 volt-	1 731 477 000
220 volt-	1 731 478 000
Special voltages	1 731 479 0 . .

DC, 4 changeover contacts, single contacts, AgCu, closed AI cover, IP 40, drop indicator, standard type

12 volt-	1 731 494 000
24 volt-	1 731 495 000
60 volt-	1 731 496 000
110 volt-	1 731 497 000
220 volt-	1 731 498 000
Special voltages	1 731 499 0 . .

DC, 4 changeover contacts, single contacts, AgCu, closed AI cover, IP 40, climatic / ship type

12 volt-	1 770 328 000
24 volt-	1 770 329 000
60 volt-	1 770 330 000
110 volt-	1 770 331 000
220 volt-	1 770 332 000
Special voltages	1 770 333 0 . .

DC, 4 changeover contacts, single contacts, AgCu, closed AI cover, IP 40, target operating current, climatic / ship type

12 volt-	1 770 322 000
24 volt-	1 770 323 000
60 volt-	1 770 324 000
110 volt-	1 770 325 000
220 volt-	1 770 326 000
Special voltages	1 770 327 0 . .

DC, 4 changeover contacts, single contacts, AgCu, closed AI cover, IP 40, target closed-circuit current, climatic / ship type

12 volt-	1 770 316 000
24 volt-	1 770 317 000
60 volt-	1 770 318 000
110 volt-	1 770 319 000
220 volt-	1 770 320 000
Special voltages	1 770 321 0 . .

DC, 4 changeover contacts, single contacts, AgCu, closed AI cover, IP 40, drop indicator, climatic / ship type

12 volt-	1 770 310 000
24 volt-	1 770 311 000
60 volt-	1 770 312 000
110 volt-	1 770 313 000
220 volt-	1 770 314 000
Special voltages	1 770 315 0 . .

DC, 4 changeover contacts, single contacts, AgCu, closed PC cover, IP 40, standard type

12 V-	1 732 691 800
24 V-	1 732 692 800
60 V-	1 732 693 800
110 V-	1 732 694 800
220 V-	1 732 695 800
Special voltages	1 732 696 8 . .

DC, 4 changeover contacts, single contacts, AgCu, closed PC cover, IP 40, climatic / ship type

12 V-	1 771 533 800
24 V-	1 771 534 800
60 V-	1 771 535 800
110 V-	1 771 536 800
220 V-	1 771 537 800
Special voltages	1 771 538 8 . .

DC, UIC, four changeover contacts, single contacts, AgCu, closed AI cover, IP 40, standard type

0.015 A	1 731 509 438
0.17 A	1 731 509 439
0.24 A	1 731 509 440
0.35 A	1 731 509 441
0.46 A	1 731 509 447
0.5 A	1 731 509 442
0.9 A	1 731 509 443
1.5 A	1 731 509 444
2.45 A	1 731 509 445
4.15 A	1 731 509 446
for other rated currents	1 731 509 4 . .

DC, UIC, four changeover contacts, single contacts, AgCu, closed AI cover, IP 40, climatic/ship type

0.015 A	1 770 333 438
0.17 A	1 770 333 439
0.24 A	1 770 333 440
0.35 A	1 770 333 441
0.46 A	1 770 333 447
0.5 A	1 770 333 442
0.9 A	1 770 333 443
1.5 A	1 770 333 444
2.45 A	1 770 333 445
4.15 A	1 770 333 446
for other rated currents	1 770 333 4 . .

DC, UIC, four changeover contacts, single contacts, AgCu, closed AI cover, IP 40, drop indicator, climatic/ship type

0.015 A	1 770 315 438
0.17 A	1 770 315 439
0.24 A	1 770 315 440
0.35 A	1 770 315 441
0.46 A	1 770 315 447
0.5 A	1 770 315 442
0.9 A	1 770 315 443
1.5 A	1 770 315 444
2.45 A	1 770 315 445
4.15 A	1 770 315 446
for other rated currents	1 770 315 4 . .

DC, 4 changeover contacts, single contacts, AgPd30, bifurcated PC cover, IP 40, standard type

12 V-	1 732 721 000
24 V-	1 732 722 000
60 V-	1 732 723 000
110 V-	1 732 724 000
220 V-	1 732 725 000
Special voltages	1 732 726 0 . .

DC, 4 changeover contacts, single contacts, AgPd30, bifurcated PC cover, IP 40, climatic / ship type

12 volt-	1 771 563 000
24 volt-	1 771 564 000
60 volt-	1 771 565 000
110 volt-	1 771 566 000
220 volt-	1 771 567 000
Special voltages	1 771 568 0 . .

RELOG 2 RH 02 All-or-Nothing Relay Types:

DC, 4 changeover contacts, twin contacts, AgCu, closed PC cover, IP 40, climatic / ship type

12 V-	1 771 292 400
24 V-	1 771 293 400
60 V-	1 771 294 400
110 V-	1 771 295 400
220 V-	1 771 296 400
Special voltages	1 771 297 4 . .

DC, 4 changeover contacts, twin contacts, AgCu, closed PC cover, IP 40, target operating current, climatic / ship type

12 volt-	1 771 298 400
24 volt-	1 771 299 400
60 volt-	1 771 300 400
110 volt-	1 771 301 400
220 volt-	1 771 302 400
Special voltages	1 771 303 4 . .

DC, 4 changeover contacts, twin contacts, AgCu4, closed PC cover, IP 40, target closed-circuit current, climatic / ship type

12 V-	1 771 304 400
24 V-	1 771 305 400
60 V-	1 771 306 400
110 V-	1 771 307 400
220 V-	1 771 308 400
Special voltages	1 771 309 4 . .

DC, 4 changeover contacts, twin contacts, AgCu, closed PC cover, IP 40, drop indicator, climatic / ship type

12 volt-	1 771 856 000
24 volt-	1 771 857 000
60 volt-	1 771 858 000
110 volt-	1 771 859 000
220 volt-	1 771 860 000
Special voltages	1 771 861 0 . .

DC, 4 changeover contacts, twin contacts, AgCu, closed PC cover, IP 40, GP02-40 diode, climatic / ship type

12 V-	1 774 012 400
24 V-	1 774 013 400
60 V-	1 774 014 400
110 V-	1 774 015 400
220 V-	1 774 016 400
Special voltages	1 774 017 4 . .

DC, 4 changeover contacts, twin contacts, AgCu, closed PC cover, IP 40, target: operating current, GP02-40 diode, climatic/ship type

12 V-	1 774 030 400
24 V-	1 774 031 400
60 V-	1 774 032 400
110 V-	1 774 033 400
220 V-	1 774 034 400
Special voltages	1 774 035 4 . .

DC, 4 changeover contacts, twin contacts, AgCu, closed PC cover, IP 40, target: closed-circuit current, GP02-40 diode, climatic/ship type

12 V-	1 774 040 400
24 V-	1 774 041 400
60 V-	1 774 042 400
110 V-	1 774 043 400
220 V-	1 774 044 400
Special voltages	1 774 045 4 . .

DC, 4 changeover contacts, twin contacts, AgCu, closed PC cover, IP 40, drop indicator, GP02-40 diode, climatic / ship type

12 V-	1 774 000 000
24 V-	1 774 001 000
60 V-	1 774 002 000
110 V-	1 774 003 000
220 V-	1 774 004 000
Special voltages	1 774 005 0 . .

DC, 4 changeover contacts, twin contacts, AgCu, closed PC cover, IP 50, climatic / ship type

12 volt-	1 771 292 000
24 volt-	1 771 293 000
60 volt-	1 771 294 000
110 volt-	1 771 295 000
220 volt-	1 771 296 000
Special voltages	1 771 297 0 . .

DC, 4 changeover contacts, twin contacts, AgCu, closed PC cover, IP 50, target operating current, climatic / ship type

12 volt-	1 771 298 000
24 volt-	1 771 299 000
60 volt-	1 771 300 000
110 volt-	1 771 301 000
220 volt-	1 771 302 000
Special voltages	1 771 303 0 . .

DC, 4 changeover contacts, twin contacts, AgCu4, closed PC cover, IP 50, target closed-circuit current, climatic / ship type

12 V-	1 771 304 000
24 V-	1 771 305 000
60 V-	1 771 306 000
110 V-	1 771 307 000
220 V-	1 771 308 000
Special voltages	1 771 309 0 . .

DC, 4 changeover contacts, twin contacts, AgCu, closed PC cover, IP 50, GP02-40 diode, climatic / ship type

12 V-	1 774 012 000
24 V-	1 774 013 000
60 V-	1 774 014 000
110 V-	1 774 015 000
220 V-	1 774 016 000
Special voltages	1 774 017 0 . .

DC, UIC, four changeover contacts, twine contacts, AgCu, closed AI cover, IP 40, climatic type

12 V-	1 771 292 500
24 V-	1 771 293 500
60 V-	1 771 294 500
110 V-	1 771 295 500
220 V-	1 771 296 500
Special voltages	1 771 297 5 . .

DC, UIC, four changeover contacts, twine contacts, AgCu, closed AI cover, IP 40, target: operating current, climatic type

12 V-	1 771 298 500
24 V-	1 771 299 500
60 V-	1 771 300 500
110 V-	1 771 301 500
220 V-	1 771 302 500
Special voltages	1 771 303 5 . .

DC, UIC, four changeover contacts, twine contacts, AgCu, closed AI cover, IP 40, target: closed-circuit current, climatic type

12 V-	1 771 304 500
24 V-	1 771 305 500
60 V-	1 771 306 500
110 V-	1 771 307 500
220 V-	1 771 308 500
Special voltages	1 771 309 5 . .

DC, UIC, four changeover contacts, twine contacts, AgCu, closed AI cover, IP 40, drop indicator, climatic type

12 V-	1 771 310 500
24 V-	1 771 311 500
60 V-	1 771 312 500
110 V-	1 771 313 500
220 V-	1 771 314 500
Special voltages	1 771 315 5 . .

DC, four changeover contacts, twin contacts, AgNi0,15 6 µm Au, closed PC cover, IP 40, climatic/ship type

12 V-	1 774 500 000
24 V-	1 774 501 000
60 V-	1 774 502 000
110 V-	1 774 503 000
220 V-	1 774 504 000
Special voltages	1 774 505 0 . .

DC, four changeover contacts, twin contacts, AgNi0,15 6 µm Au, closed PC cover, IP 40, target: operating current, climatic/ship type

12 V-	1 774 537 000
24 V-	1 774 538 000
60 V-	1 774 539 000
110 V-	1 774 540 000
220 V-	1 774 541 000
Special voltages	1 774 542 0 . .

DC, four changeover contacts, twin contacts, AgNi0,15 6 µm Au, closed PC cover, IP 40, target: closed-circuit current, climatic/ship type

12 V-	1 774 543 000
24 V-	1 774 544 000
60 V-	1 774 545 000
110 V-	1 774 546 000
220 V-	1 774 547 000
Special voltages	1 774 548 0 . .

DC, four changeover contacts, twin contacts, AgNi0,15 6 µm Au, closed PC cover, IP 40, target: drop indicator, climatic/ship type

12 V-	1 774 549 000
24 V-	1 774 550 000
60 V-	1 774 551 000
110 V-	1 774 552 000
220 V-	1 774 553 000
Special voltages	1 774 554 0 . .

DC, four changeover contacts, twin contacts, AgNi0,15 6 µm Au, closed PC cover, IP 50, climatic type

12 V-	1 774 512 000
24 V-	1 774 513 000
60 V-	1 774 514 000
110 V-	1 774 515 000
220 V-	1 774 516 000
Special voltages	1 774 517 0 . .

DC, four changeover contacts, twin contacts, AgNi0,15 6 µm Au, closed PC cover, IP 50, target: operating current, climatic type

12 volt-	1 774 518 000
24 volt-	1 774 519 000
60 volt-	1 774 520 000
110 volt-	1 774 521 000
220 volt-	1 774 522 000
Special voltages	1 774 523 0 . .

DC, four changeover contacts, twin contacts, AgNi0,15 6 µm Au, closed PC cover, IP 50, target: closed-circuit current, climatic type

12 volt-	1 774 524 000
24 volt-	1 774 525 000
60 volt-	1 774 526 000
110 volt-	1 774 527 000
220 volt-	1 774 528 000
Special voltages	1 774 529 0 . .

DC, four changeover contacts, twin contacts, AgNi0,15 6 µm Au, closed PC cover, IP 40, target: drop indicator, GP02-40 diode, climatic/ship type

12 V-	1 774 506 000
24 V-	1 774 507 000
60 V-	1 774 508 000
110 V-	1 774 509 000
220 V-	1 774 510 000
Special voltages	1 774 511 0 . .

DC, four changeover contacts, twin contacts AgPd30, closed PC cover, IP 40, climatic/ship type

12 volt-	1 771 868 000
24 volt-	1 771 869 000
60 volt-	1 771 870 000
110 volt-	1 771 871 000
220 volt-	1 771 872 000
Special voltages	1 771 873 0 . .

DC, four changeover contacts, twin contacts AgPd30, closed PC cover, IP 40, target: operating current, climatic/ship type

12 volt-	1 771 874 000
24 volt-	1 771 875 000
60 volt-	1 771 876 000
110 volt-	1 771 877 000
220 volt-	1 771 878 000
Special voltages	1 771 879 0 . .

DC, four changeover contacts, twin contacts AgPd30, closed PC cover, IP 40, target: closed-circuit current, climatic/ship type

12 volt-	1 771 880 000
24 volt-	1 771 881 000
60 volt-	1 771 882 000
110 volt-	1 771 883 000
220 volt-	1 771 884 000
Special voltages	1 771 885 0 . .

DC, four changeover contacts, twin contacts AgPd30, closed PC cover, IP 40, target: drop indicator, climatic/ship type

12 volt-	1 771 886 000
24 volt-	1 771 887 000
60 volt-	1 771 888 000
110 volt-	1 771 889 000
220 volt-	1 771 890 000
Special voltages	1 771 891 0 . .

DC, four changeover contacts, twin contacts AgPd30, closed PC cover, IP 40, GP02-40 diode, climatic/ship type

12 volt-	1 774 050 000
24 volt-	1 774 051 000
60 volt-	1 774 052 000
110 volt-	1 774 053 000
220 volt-	1 774 054 000
Special voltages	1 774 055 0 . .

DC, four changeover contacts, twin contacts AgPd30, closed PC cover, IP 40, , GP02-40 diode, drop indicator, climatic/ship type

12 volt-	1 774 006 000
24 volt-	1 774 007 000
60 volt-	1 774 008 000
110 volt-	1 774 009 000
220 volt-	1 774 010 000
Special voltages	1 774 011 0 . .

DC, UIC, four changeover contacts, twin contacts, AgPd30, closed AI cover, IP 40, climatic type

12 volt-	1 771 868 500
24 volt-	1 771 869 500
60 volt-	1 771 870 500
110 volt-	1 771 871 500
220 volt-	1 771 872 500
Special voltages	1 771 873 5 . .

DC, UIC, four changeover contacts, twin contacts, AgPd30, closed AI cover, IP 40, target: operating current, climatic type

12 volt-	1 771 874 500
24 volt-	1 771 875 500
60 volt-	1 771 876 500
110 volt-	1 771 877 500
220 volt-	1 771 878 500
Special voltages	1 771 879 5 . .

DC, UIC, four changeover contacts, twin contacts, AgPd30, closed Al cover, IP 40, target: closed-circuit current, climatic type

12 volt-	1 771 880 500
24 volt-	1 771 881 500
60 volt-	1 771 882 500
110 volt-	1 771 883 500
220 volt-	1 771 884 500
Special voltages	1 771 885 5 . .

DC, UIC, four changeover contacts, twin contacts, AgPd30, closed Al cover, IP 40, drop indicator, climatic type

12 volt-	1 771 886 500
24 volt-	1 771 887 500
60 volt-	1 771 888 500
110 volt-	1 771 889 500
220 volt-	1 771 890 500
Special voltages	1 771 891 5 . .

RELOG 4 RH 10 All-or-Nothing Relay Types:

DC, eight changeover contacts, single contacts, AgCu, closed Al cover, IP 40, standard type

12 V-	1 731 464 000
24 V-	1 731 465 000
60 V-	1 731 466 000
110 V-	1 731 467 000
220 V-	1 731 468 000
Special voltages	1 731 469 0 . .

DC, UIC, eight changeover contacts, single contacts, AgCu, closed Al cover, IP 40, standard type

12 V-	1 731 464 500
24 V-	1 731 465 500
60 V-	1 731 466 500
110 V-	1 731 467 500
220 V-	1 731 468 500
Special voltages	1 731 469 5 . .

DC, eight changeover contacts, single contacts, AgCu, closed Al cover, IP 40, climatic/ship type

12 volt-	1 770 437 000
24 volt-	1 770 438 000
60 volt-	1 770 439 000
110 volt-	1 770 440 000
220 volt-	1 770 441 000
Special voltages	1 770 442 0 . .

DC, UIC, eight changeover contacts, single contacts, AgCu, closed Al cover, IP 40, climatic type

12 volt-	1 770 437 500
24 volt-	1 770 438 500
60 volt-	1 770 439 500
110 volt-	1 770 440 500
220 volt-	1 770 441 500
Special voltages	1 770 442 5 . .

RELOG 4 RH 12 All-or-Nothing Relay Types:

DC, eight changeover contacts, twin contacts, AgCu, closed Al cover, IP 40, climatic type

12 V-	1 770 510 000
24 V-	1 770 511 000
60 V-	1 770 512 000
110 V-	1 770 513 000
220 V-	1 770 514 000
Special voltages	1 770 515 0 . .

DC, UIC, eight changeover contacts, twine contacts, AgCu, closed Al cover, IP 40, climatic type

12 V-	1 770 510 500
24 V-	1 770 511 500
60 V-	1 770 512 500
110 V-	1 770 513 500
220 V-	1 770 514 500
Special voltages	1 770 515 5 . .

RELOG 2 RH 60 All-or-Nothing Relay Types:

remanence relay, four changeover contacts, single contacts, AgCu, bifurcated PC cover, IP 40, standard type

12 V-	1 731 880 000
24 V-	1 731 881 000
60 V-	1 731 882 000
110 V-	1 731 883 000
220 V-	1 731 884 000
Special voltages	1 731 885 0 . .

remanence relay, four changeover contacts, single contacts, AgCu, bifurcated PC cover, IP 40, target: closed-circuit current, standard type

12 V-	1 731 724 000
24 V-	1 731 725 000
60 V-	1 731 726 000
110 V-	1 731 727 000
220 V-	1 731 728 000
Special voltages	1 731 729 0 . .

remanence relay, four changeover contacts, single contacts, AgCu, closed PC cover, IP 40, target: operating current, Standard type

12 V-	1 731 524 000
24 V-	1 731 525 000
60 V-	1 731 526 000
110 V-	1 731 527 000
220 V-	1 731 528 000
Special voltages	1 731 529 0 . .

RELOG 2 RH 62 All-or-Nothing Relay Types:

remanence relay, four changeover contacts, single contacts, AgCu, closed PC cover, IP 40, Standard type

12 volt-	1 731 880 990
24 volt-	1 731 881 990
60 volt-	1 731 882 990
110 volt-	1 731 883 990
220 volt-	1 731 884 990
Special voltages	1 731 885 990

remanence relay, four changeover contacts, single contacts, AgCu, closed PC cover, IP 40, target: operating current, Standard type

12 V-	1 731 249 000
24 V-	1 731 250 000
60 V-	1 731 251 000
110 V-	1 731 252 000
220 V-	1 731 253 000
Special voltages	1 731 254 0 . .

remance relay, four changeover contacts, single contacts, AgCu,
closed PC cover, IP 40, target: closed-circuit current,
Standard type

12 volt-	1 731 714 000
24 volt-	1 731 715 000
60 volt-	1 731 716 000
110 volt-	1 731 717 000
220 volt-	1 731 718 000
Special voltages	1 731 719 0 . .

RELOG 2 RH 30 All-or-Nothing Relay Types:

AC, 50 Hz, four changeover contacts, single contacts, AgCu,
bifurcated PC cover, IP 40,
Standard type

24 V~	1 732 791 000
42 V~	1 732 792 000
60 V~	1 732 793 000
127 V~	1 732 794 000
230 V~	1 732 795 000
Special voltages	1 732 796 0 . .

AC, 50 Hz, four changeover contacts, single contacts, AgCu,
closed PC cover, IP 40, target: operating current,
Standard type

24 V~	1 732 803 000
42 V~	1 732 804 000
60 V~	1 732 805 000
127 V~	1 732 806 000
230 V~	1 732 807 000
Special voltages	1 732 808 0 . .

DC, 50 Hz, four changeover contacts, single contacts, AgCu,
bifurcated PC cover, IP 40, target: closed-circuit current,
Standard type

24 V~	1 732 809 000
42 V~	1 732 810 000
60 V~	1 732 811 000
127 V~	1 732 812 000
230 V~	1 732 813 000
Special voltages	1 732 814 0 . .

AC, 50 Hz, four changeover contacts, single contacts, AgCu,
bifurcated PC cover, IP 40, target: drop indicator,
Standard type

24 V~	1 732 797 000
42 V~	1 732 798 000
60 V~	1 732 799 000
127 V~	1 732 800 000
230 V~	1 732 801 000
Special voltages	1 732 802 0 . .

AC, 50 Hz, four changeover contacts, single contacts, AgCu,
bifurcated PC cover, IP 40,
climatic/ship type

24 V~	1 771 575 000
42 V~	1 771 576 000
60 V~	1 771 577 000
127 V~	1 771 578 000
230 V~	1 771 579 000
Special voltages	1 771 580 0 . .

AC, 50 Hz, four changeover contacts, single contacts, AgCu,
closed PC cover, IP 40, target: operating current,
climatic/ship type

24 V~	1 771 587 000
42 V~	1 771 588 000
60 V~	1 771 589 000
127 V~	1 771 590 000
230 V~	1 771 591 000
Special voltages	1 771 592 0 . .

AC, 50 Hz, four changeover contacts, single contacts, AgCu,
bifurcated PC cover, IP 40, target: closed-circuit current,
climatic/ship type

24 V~	1 771 593 000
42 V~	1 771 594 000
60 V~	1 771 595 000
127 V~	1 771 596 000
230 V~	1 771 597 000
Special voltages	1 771 598 0 . .

DC, 50 Hz, four changeover contacts, single contacts, AgCu,
bifurcated PC cover, IP 40, target: drop indicator,
climatic/ship type

24 V~	1 771 581 000
42 V~	1 771 582 000
60 V~	1 771 583 000
127 V~	1 771 584 000
230 V~	1 771 585 000
Special voltages	1 771 586 0 . .

AC, 50 Hz, four changeover contacts, single contacts, AgCu,
closed PC cover, IP 40,
Standard type

24 V~	1 732 791 800
42 V~	1 732 792 800
60 V~	1 732 793 800
127 V~	1 732 794 800
230 V~	1 732 795 800
Special voltages	1 732 796 8 . .

DC, 50 Hz, four changeover contacts, single contacts, AgCu,
closed PC cover, IP 40,
climatic/ship type

24 V~	1 771 575 800
42 V~	1 771 576 800
60 V~	1 771 577 800
127 V~	1 771 578 800
230 V~	1 771 579 800
Special voltages	1 771 580 8 . .

AC, 50 Hz, four changeover contacts, single contacts, AgCu,
closed AI cover, IP 40,
Standard type

24 V~	1 731 280 000
42 V~	1 731 281 000
60 V~	1 731 282 000
127 V~	1 731 283 000
230 V~	1 731 284 000
Special voltages	1 731 285 0 . .

AC, 50 Hz, four changeover contacts, single contacts, AgCu,
closed AI cover, IP 40,
climatic type

24 V~	1 770 455 000
42 V~	1 770 456 000
60 V~	1 770 457 000
127 V~	1 770 458 000
230 V~	1 770 459 000
Special voltages	1 770 460 0 . .

DC, 50 Hz, four changeover contacts, single contacts, AgCu,
closed AI cover, IP 40, target: operating current,
climatic type

24 V~	1 770 487 000
42 V~	1 770 488 000
60 V~	1 770 489 000
127 V~	1 770 490 000
230 V~	1 770 491 000
Special voltages	1 770 492 0 . .

AC, 50 Hz, four changeover contacts, single contacts, AgCu,
closed AI cover, IP 40, target: closed-circuit current,
climatic type

24 V~	1 770 493 000
42 V~	1 770 494 000
60 V~	1 770 495 000
127 V~	1 770 496 000
230 V~	1 770 497 000
Special voltages	1 770 498 0 . .

AC, 50 Hz, four changeover contacts, single contacts, AgCu4,
closed AI cover, IP 40, target: drop indicator,
climatic type

24 V~	1 770 481 000
42 V~	1 770 482 000
60 V~	1 770 483 000
127 V~	1 770 484 000
230 V~	1 770 485 000
Special voltages	1 770 486 0 . .

AC, 60 Hz, four changeover contacts, single contacts, AgCu,
closed AI cover, IP 40,
climatic/ship type

24 V~	1 770 455 600
42 V~	1 770 456 600
60 V~	1 770 457 600
127 V~	1 770 458 600
220 V~	1 770 459 600
Special voltages	1 770 460 0 . .

AC, 50 Hz, four changeover contacts, single contacts, AgCu,
closed AI cover, IP 40,
climatic/ship type

0.34 A~	1 770 460 450
0.40 A~	1 770 460 451
0.53 A~	1 770 460 452
0.60 A~	1 770 460 453
0.70 A~	1 770 460 454
0.95 A~	1 770 460 455
1.33 A~	1 770 460 456
1.80 A~	1 770 460 457

RELOG 2 RH 32 All-or-Nothing Relay Types:

AC, 50 Hz, four changeover contacts, twin contacts, AgCu,
closed PC cover, IP 40,
climatic/ship type

24 V~	1 771 854 400
42 V~	1 771 855 400
60 V~	1 771 838 400
127 V~	1 771 839 400
230 V~	1 771 840 400
Special voltages	1 771 841 4 . .

AC, 50 Hz, four changeover contacts, twin contacts, AgCu,
closed PC cover, IP 40, target: operating current,
climatic/ship type

24 V~	1 771 842 400
42 V~	1 771 843 400
60 V~	1 771 844 400
127 V~	1 771 845 400
230 V~	1 771 846 400
Special voltages	1 771 847 4 . .

AC, 60 Hz, four changeover contacts, single contacts, AgCu,
closed AI cover, IP 40, target: operating current,
climatic/ship type

24 V~	1 770 487 600
42 V~	1 770 488 600
60 V~	1 770 489 600
127 V~	1 770 490 600
220 V~	1 770 491 600
Special voltages	1 770 492 6 . .

AC, 60 Hz, four changeover contacts, single contacts, AgCu,
closed AI cover, IP 40, target: closed-circuit current,
climatic/ship type

24 V~	1 770 493 600
42 V~	1 770 494 600
60 V~	1 770 495 600
127 V~	1 770 496 600
220 V~	1 770 497 600
Special voltages	1 770 498 6 . .

AC, 60 Hz, four changeover contacts, single contacts, AgCu4,
closed AI cover, IP 40, target: drop indicator,
climatic/ship type

24 V~	1 770 481 600
42 V~	1 770 482 600
60 V~	1 770 483 600
127 V~	1 770 484 600
220 V~	1 770 485 600
Special voltages	1 770 486 600

AC, 50 Hz, four changeover contacts, single contacts, AgCu,
closed AI cover, IP 40,
Standard type

0.34 A~	1 731 285 450
0.40 A~	1 731 285 451
0.53 A~	1 731 285 452
0.60 A~	1 731 285 453
0.70 A~	1 731 285 454
0.95 A~	1 731 285 455
1.33 A~	1 731 285 456
1.80 A~	1 731 285 457

AC, 50 Hz, four changeover contacts, twin contacts, AgCu,
closed PC cover, IP 40, target: closed-circuit current,
climatic/ship type

24 V~	1 771 848 400
42 V~	1 771 849 400
60 V~	1 771 850 400
127 V~	1 771 851 400
230 V~	1 771 852 400
Special voltages	1 771 853 4 . .

AC, 50 Hz, four changeover contacts, twin contacts, AgCu,
closed PC cover, IP 40, target: drop indicator,
climatic/ship type

24 V~	1 771 862 000
42 V~	1 771 863 000
60 V~	1 771 864 000
127 V~	1 771 865 000
230 V~	1 771 866 000
Special voltages	1 771 867 0 . .

AC, 50 Hz, four changeover contacts, twin contacts,
AgNi0,15 6 µm Au, closed PC cover, IP 40, climatic type

24 V~	1 774 555 000
42 V~	1 774 556 000
60 V~	1 774 557 000
127 V~	1 774 558 000
230 V~	1 774 559 000
Special voltages	1 774 560 0 . .

AC, 50 Hz, four changeover contacts, twin contacts,
AgNi0,15 6 µm Au, closed PC cover, IP 40, target: operating current,
climatic type

24 V~	1 774 561 000
42 V~	1 774 562 000
60 V~	1 774 563 000
127 V~	1 774 564 000
230 V~	1 774 565 000
Special voltages	1 774 566 0 . .

AC, 50 Hz, four changeover contacts, twin contacts,
AgNi0,15 6 µm Au, closed PC cover, IP 40, target: closed-circuit
current, climatic type

24 V~	1 774 567 000
42 V~	1 774 568 000
60 V~	1 774 569 000
127 V~	1 774 570 000
230 V~	1 774 571 000
Special voltages	1 774 572 0 . .

AC, 50 Hz, four changeover contacts, twin contacts,
AgNi0,15 6 µm Au, closed PC cover, IP 40, target: drop indicator,
climatic type

24 V~	1 774 573 000
42 V~	1 774 574 000
60 V~	1 774 575 000
127 V~	1 774 576 000
230 V~	1 774 577 000
Special voltages	1 774 578 0 . .

AC, 50 Hz, four changeover contacts, twin contacts,
AgNi0,15 6 µm Au, closed PC cover, IP 50, climatic type

24 V~	1 774 531 000
42 V~	1 774 532 000
60 V~	1 774 533 000
127 V~	1 774 534 000
230 V~	1 774 535 000
Special voltages	1 774 536 0 . .

DC, four changeover contacts, twin contacts, AgCu,
closed PC cover, IP 50, target: operating current,
climatic/ship type

24 V~	1 771 842 000
42 V~	1 771 843 000
60 V~	1 771 844 000
127 V~	1 771 845 000
230 V~	1 771 846 000
Special voltages	1 771 847 0 . .

AC, 50 Hz, four changeover contacts, twin contacts, AgCu,
closed PC cover, IP 50, target: closed-circuit current,
climatic/ship type

24 V~	1 771 848 000
42 V~	1 771 849 000
60 V~	1 771 850 000
127 V~	1 771 851 000
230 V~	1 771 852 000
Special voltages	1 771 853 000

AC, 50 Hz, four changeover contacts, twin contacts, AgCu,
closed PC cover, IP 50,
climatic/ship type

24 V~	1 771 854 000
42 V~	1 771 855 000
60 V~	1 771 838 000
127 V~	1 771 839 000
230 V~	1 771 840 000
Special voltages	1 771 841 0 . .

RELOG 4 RH 40 All-or-Nothing Relay Types:

AC, 50 Hz, eight changeover contacts, single contacts, AgCu,
closed AI cover, IP 40,
Standard type

24 V~	1 731 444 000
42 V~	1 731 445 000
60 V~	1 731 446 000
127 V~	1 731 447 000
230 V~	1 731 448 000
Special voltages	1 731 449 0 . .

AC, 60 Hz, eight changeover contacts, single contacts, AgCu,
closed AI cover, IP 40,
Standard type

24 V~	1 731 444 600
42 V~	1 731 445 600
60 V~	1 731 446 600
127 V~	1 731 447 600
220 V~	1 731 448 600
Special voltages	1 731 449 6 . .

AC, 50 Hz, eight changeover contacts, single contacts, AgCu,
closed AI cover, IP 40,
climatic/ship type

24 V~	1 770 443 000
42 V~	1 770 444 000
60 V~	1 770 445 000
127 V~	1 770 446 000
230 V~	1 770 447 000
Special voltages	1 770 448 0 . .

AC, 60 Hz, eight changeover contacts, single contacts, AgCu,
closed AI cover, IP 40,
climatic/ship type

24 V~	1 770 443 600
42 V~	1 770 444 600
60 V~	1 770 445 600
127 V~	1 770 446 600
220 V~	1 770 447 600
Special voltages	1 770 448 6 . .

RELOG 4 RH 42 All-or-Nothing Relay Types:

AC, 50 Hz, eight changeover contacts, single contacts, AgCu,
closed AI cover, IP 40,
climatic type

24 V~	1 770 520 000
42 V~	1 770 521 000
60 V~	1 770 522 000
127 V~	1 770 523 000
230 V~	1 770 524 000
Special voltages	1 770 525 0 . .

List of Extended Order Numbers

The 9th and 10th digit of the order number acc. to the "List of Order Numbers (Pl.nos) must be supplemented with the requested special voltage.

Special voltage	9. and 10. digit of the Pl. nos.
6 V DC	1 11
12 V AC	1 01
32 V DC	1 03
36 V DC	1 10
36 V AC	1 10
42 V DC	1 04
48 V DC	1 05
48 V AC	1 05
52 V DC	1 12
80 V DC	1 07
96 V DC	1 14
100 V DC	1 08
100 V AC	1 08
110 V AC	1 11
125 V DC	1 09
250 V DC	1 13
400 V AC	1 12

Other special voltages upon request.

Accessoires

Plug-in connection with quick-rail fixing, DIN labeling	1 739 245 000
Plug-in connection with quick-rail fixing, RELOG labeling	1 739 245 100
Plug-in connection with quick rail fixing, GP02-40 diode ($U_{RRM} = 4$ kV), DIN labeling	1 739 245 010
Plug-in connection with quick rail fixing, BYW 56 diode ($U_{RRM} = 1$ kV), DIN labeling	1 739 245 011
Plug-in connection with quick rail fixing, GP02-40 diode ($U_{RRM} = 40$ kV), RELOG labeling	1 739 245 110
Plug-in connection with quick rail fixing, BYW 56 diode ($U_{RRM} = 1$ kV), RELOG labeling	1 739 245 111
Fastening sheet "Single-screw fixing" for plug-in connection with quick-rail fixing	1 739 246 000
RELOG Adaptor connected for 2 RH all-or-nothing relay	1 739 194 000
RELOG Adaptor for 2 RH all-or-nothing relay . / 4 RH . without wiring	1 739 195 000
Plug-in connection for 2 H all-or-nothing relay 14 poles, solder termination	1 770 335 000
Plug-in connection for 2 H all-or-nothing relay 14 poles, wire-wrap termination	1 770 594 000
plug-in connection 22 poles, solder termination	1 770 334 000
plug-in connection 22 poles, wire-wrap termination	1 770 595 000

Schließen Sie Kontakt mit uns!

Make contact with us!

Die Experten der EAW Relaistechnik GmbH nehmen sich gern Zeit für ein informatives Gespräch mit Ihnen. Natürlich kostenlos und unverbindlich. So haben Sie Gewissheit, dass wir die richtigen Partner sind.

The specialists of EAW Relaistechnik GmbH will be glad to take time out to meet you for informative talks. Convince yourself – without charge – that you have found the right partner in us.



EAW RELAISTECHNIK GMBH
Hauptstraße 13
10317 Berlin, Germany
www.eaw-relaistechnik.de

Phone +49-30-55 76 22 00
Fax +49-30-55 76 22 03
e-mail vertrieb@eaw-relaistechnik.de

